

# P25 Radio Systems



## Training Guide

**DE DANIELS™**  
ELECTRONICS LTD.

[www.danelec.com](http://www.danelec.com)





# **P25 Radio Systems**

## **Training Guide**

## NOTE

Copyright © 2004 Daniels Electronics Ltd. All rights reserved. No part of this publication may be reproduced, stored in a retrieval system or transmitted in any form or by any means, electronic, mechanical, photocopying, recording or otherwise, without the prior written consent of Daniels Electronics Ltd.

DE™ is a registered trademark of Daniels Electronic Ltd. registered in the U.S. Patent and Trademark Office.

IMBE™ and AMBE+2™ are trademarks of Digital Voice Systems, Inc.

EDACS® is a registered trademark of M/A-COM, Inc.

Aegis™ is a trademark of M/A-COM, Inc.

iDEN™ is a trademark of Motorola, Inc.

GSM™ is a trademark of GSM Association.

ANSI® is a registered trademark of the American National Standards Institute

DOCUMENT REVISION  
DEFINITION

Daniels Electronics Ltd. utilizes a three-level revision system. This system enables Daniels to identify the significance of a revision. Each element of the revision number signifies the scope of change as described in the diagram below.

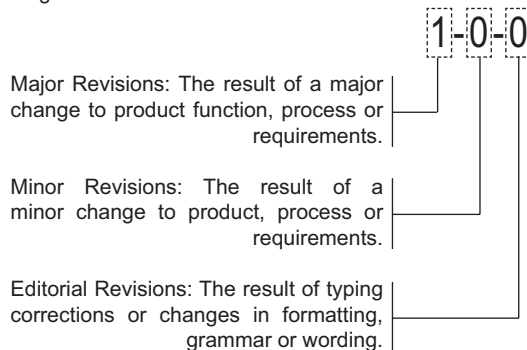

Three-level revision numbers start at 1-0-0 for the first release. The appropriate element of the revision number is incremented by 1 for each subsequent revision, causing any digits to the right to be reset to 0.

For example:

If the current revision = 2-1-1 Then the next major revision = 3-0-0

If the current revision = 4-3-1 Then the next minor revision = 4-4-0

If the current revision = 3-2-2 Then the next editorial revision = 3-2-3

**Daniels Electronics Ltd.**  
43 Erie Street, Victoria, BC  
Canada V8V 1P8  
www.danelec.com  
sales@danelec.com

Toll Free Canada and USA:  
phone: 1-800-664-4066  
fax: 1-877-750-0004

International:  
phone: 250-382-8268  
fax: 250-382-6139

PRINTED IN CANADA

Document Number: TG-001  
Revision: 1-0-1  
Revision Date: August 2005

For the past 50 years Daniels has provided customers in North America and internationally with highly reliable Base Stations and Repeaters that are environmentally robust to operate in rugged and extreme temperature conditions where low current consumption (solar powered) is a key requirement.

ABOUT DANIELS  
ELECTRONICS LTD.

Daniels has been a pioneering member of the P25 Digital standard, for radio system interoperability between emergency response governmental organizations, providing enhanced functionality and encryption. Our products operate between 29 - 960 MHz and are available in a variety of Base Station and Repeater configurations for two way voice and mobile data applications.

Our self-servicing customers range from Forestry and National Park services through Police and Fire departments and on to Utility and Transportation groups. Our products have been deployed in every imaginable situation from the Antarctic to Hawaiian mountaintops to Alaska, enabling respondents to Forest Fires, Ground Zero rescue and routine patrols.

Daniels is an industry leader in Analog and P25 radio systems design. We offer modular rack mounted Base Stations and Repeaters capable of operating in the following bands:

Low Band VHF  
VHF AM  
VHF FM  
UHF FM  
800 MHz  
900 MHz

Pete Lunness is a member of the Applied Science Technologists & Technicians of British Columbia and has a Diploma in Electronics Engineering Technology from Camosun College in Victoria, B.C.

ABOUT THE AUTHOR

Pete has worked as a radio technician for the B.C. Ministry of Forests, helping to tune, maintain and install some of the more than 350 Daniels Electronics repeater systems owned by the Forest Service throughout British Columbia. He has been at Daniels for eight years, working in the Engineering (Design and Development) department, the Sales department and most recently in the Technical Services department. For the past five years, Pete has been the instructor for Daniels technical training courses on the MT-3 analog and MT-4 P25 digital radio systems.

Many employees throughout Daniels Electronics helped write, compile, research and check the information contained in this document including Ali Mehrpouyan, Steve Burfoot, Ron Backlund, Sean Bourquin, Pawan Premi, Peter Chan and Dale Reitsma.

REFERENCES Many references were used in the creation of this document. Following is a list of references for P25 information:

---

Aeroflex, Inc.

Aeroflex Incorporated is a multi-faceted high-technology company that designs, develops, manufactures and markets a diverse range of microelectronic and test and measurement products. Aeroflex is the manufacturer of the IFR 2975 P25 Radio Test Set.

[www.P25.com](http://www.P25.com)

[www.ifrsys.com](http://www.ifrsys.com)

---

APCO International

The Association of Public-Safety Communications Officials - International, Inc. is the world's oldest and largest not-for-profit professional organization dedicated to the enhancement of public safety communications

[www.apcointl.org](http://www.apcointl.org)

---

DVSI

Digital Voice Systems, Inc., using its proprietary voice compression technology, specializes in low-data-rate, high-quality speech compression products for wireless communications, digital storage, and other applications. DVSI is the manufacturer of the IMBE and AMBE+2 vocoders.

[www.dvsinc.com](http://www.dvsinc.com)

---

PTIG

The Project 25 Technology Interest Group (PTIG) is a group composed of public safety professionals and equipment manufacturers with a direct stake in the further development of, and education on, the P25 standards. PTIG's purpose is to further the design, manufacture, evolution, and effective use of technologies stemming from the P25 standardization process.

[www.project25.org](http://www.project25.org)

---

TIA

The Telecommunications Industry Association is the leading U.S. non-profit trade association serving the communications and information technology industry, with proven strengths in market development, trade shows, domestic and international advocacy, standards development and enabling e-business.

[www.tiaonline.org](http://www.tiaonline.org)

---

# Contents

|  |    |
|--|----|
| Chapter 1: Introduction To P25 .....                 | 1  |
| What is Project 25? .....                            | 1  |
| P25 Phases .....                                     | 2  |
| Conventional vs. Trunked .....                       | 3  |
| How does P25 work? .....                             | 4  |
| P25 Radio System Architecture .....                  | 5  |
| Benefits of P25 .....                                | 8  |
| Other Digital Standards .....                        | 12 |
| P25 Participants .....                               | 14 |
| Chapter 2: P25 Interface Standards .....             | 17 |
| P25 Standards – General System Model .....           | 17 |
| RF Sub-System .....                                  | 19 |
| Common Air Interface .....                           | 19 |
| Inter-System Interface .....                         | 20 |
| Telephone Interconnect Interface .....               | 21 |
| Network Management Interface .....                   | 21 |
| Data Host or Network Interface .....                 | 21 |
| Data Peripheral Interface .....                      | 22 |
| Fixed Station Interface .....                        | 22 |
| Console Sub-System Interface .....                   | 23 |
| Chapter 3: P25 Practical Applications .....          | 25 |
| Analog to P25 Transition .....                       | 25 |
| P25 Frequency Bands .....                            | 25 |
| P25 Digital Code Definitions .....                   | 26 |
| P25 Voice Message Options .....                      | 34 |
| P25 Encryption .....                                 | 37 |
| Analog vs. P25 Digital Coverage .....                | 38 |
| P25 Radio System Testing .....                       | 41 |
| P25 vs. Analog Delay Times .....                     | 43 |
| Chapter 4: Anatomy of the Common Air Interface ..... | 47 |
| Voice .....  | 47 |
| Data .....   | 48 |
| Frame Synchronization and Network Identifier .....   | 48 |
| Status Symbols .....                                 | 49 |
| Header Data Unit .....                               | 49 |
| Voice Code Words .....                               | 50 |
| Logical LINK Data Unit 1 .....                       | 51 |
| Logical LINK Data Unit 2 .....                       | 52 |
| Low Speed Data .....                                 | 53 |
| Terminator Data Unit .....                           | 53 |
| Packet Data Unit .....                               | 55 |
| Chapter 5: IMBE™ And AMBE+2™ Vocoders .....          | 57 |
| Chapter 6: P25 Glossary of Terms .....               | 59 |







## CHAPTER 1: INTRODUCTION TO P25

This document is written with the intention of supplying the reader with a simple, concise and informative description of Project 25. The document assumes the reader is familiar with conventional Two-Way Radio Communications systems.

Project 25 is a standards initiative, to be amended, revised, and added to as the users identify issues, and as experience is gained.

### WHAT IS PROJECT 25?

Project 25 (P25) is a set of standards produced through the joint efforts of the Association of Public Safety Communications Officials International (APCO), the National Association of State Telecommunications Directors (NASTD), selected Federal Agencies and the National Communications System (NCS), and standardized under the Telecommunications Industry Association (TIA). P25 is an open architecture, user driven suite of system standards that define digital radio communications system architectures capable of serving the needs of Public Safety and Government organizations. The P25 suite of standards involves digital Land Mobile Radio (LMR) services for local, state/provincial and national (federal) public safety organizations and agencies. P25 open system standards define the interfaces, operation and capabilities of any P25 compliant radio system. In other words, a P25 radio is any radio that conforms to the P25 standard in the way it functions or operates. P25 compliant radios can communicate in analog mode with legacy radios and in either digital or analog mode with other P25 radios. The P25 standard exists in the public domain, allowing any manufacturer to produce a P25 compatible radio product.

P25 is applicable to LMR equipment authorized or licensed in the U.S. under the National Telecommunications and Information Administration (NTIA) or Federal Communications Commission (FCC) rules and regulations.

Although developed primarily for North American public safety services, P25 technology and products are not limited to public safety alone and have also been selected and deployed in other private system applications, worldwide. The Project 25 users' process is governed by an eleven-member steering committee made up of nine U.S. federal, state and local government employees and two co-directors. From its inception, Project 25 has had four main objectives:

- 
- ensure competition in system life cycle procurements through Open Systems Architecture
- 
- allow effective, efficient and reliable intra-agency and inter-agency communications
- 
- provide enhanced functionality and capabilities with a focus on public safety needs
- 
- improve radio spectrum efficiency
- 

TIA (Telecommunications Industry Association) is a national trade organization of manufacturers and suppliers of telecommunications equipment and services. It has substantial experience in the technical aspects of radio communications and in the formulation of standards with reference thereto. TIA is accredited by the American National Standards Institute (ANSI®) as a Standards Developing Organization.

## P25 PHASES

P25-compliant technology is being deployed in several phases.

### Phase 1

Phase 1 radio systems operate in 12.5 KHz analog, digital or mixed mode. Phase 1 radios use Continuous 4 level FM (C4FM) non-linear modulation for digital transmissions. Phase 1 P25-compliant systems are backward compatible and interoperable with legacy systems, across system boundaries, and regardless of system infrastructure. In addition, the P25 suite of standards provide an open interface to the radio frequency (RF) subsystem to facilitate interlinking of different vendors' systems.

### Phase 2

Phase 2 is currently under development with the goal of defining either FDMA and/or TDMA standards to achieve one voice channel or a minimum 4800 bps data channel per 6.25 kHz bandwidth efficiency. P25 Phase 2 implementation involves time and frequency modulation schemes (e.g., TDMA and FDMA), with the goal of improved spectrum utilization. Also being stressed are such features as interoperability with legacy equipment, interfacing between repeaters and other subsystems, roaming capacity and spectral efficiency/channel reuse.

## Phase 3

Implementation of Phase 3 will address the need for high-speed data for public-safety use. Activities will encompass the operation and functionality of a new aeronautical and terrestrial wireless digital wideband/broadband public safety radio standard that can be used to transmit and receive voice, video and high-speed data in wide-area, multiple-agency networks. The European Telecommunications Standards Institute (ETSI) and TIA are working collaboratively on Phase 3, known as Project MESA (Mobility for Emergency and Safety Applications). Current P25 systems and future Project MESA technology will share many compatibility requirements and functionalities.

This document deals almost exclusively with P25 Phase 1. Phase 2 and Phase 3 standards are under development.

## CONVENTIONAL VS. TRUNKED

In general, radio systems can be separated into conventional and trunked systems. A conventional system is characterized by relatively simple geographically fixed infrastructure (such as a repeater network) that serves to repeat radio calls from one frequency to another. A trunked system is characterized by a controller in the infrastructure which assigns calls to specific channels. P25 supports both trunked and conventional radio systems. This document, however, deals primarily with conventional radio systems.

## HOW DOES P25 WORK?

P25 radios operate very similar to conventional analog FM radios. In fact, P25 radios will operate in conventional analog mode, making them backwards compatible with existing analog radio systems. When the P25 radio operates in digital mode, the carrier is moved to four specific frequency offsets that represent four different two-bit combinations. This is a modified 4 level FSK used in analog radio systems. In analog mode, the P25 radio will operate exactly the same as conventional analog systems, with the capability for CTCSS, DCS, pre-emphasis and de-emphasis, wideband or narrowband operation and other standard analog features.

In P25 digital mode, the P25 transmitter will convert all analog audio to packets of digital information by using an IMBE™ vocoder, then de-vocode the digital information back to analog audio in the receiver. Error correction coding is added to the digital voice information as well as other digital information. Analog CTCSS and DCS are replaced by digital NAC codes (as well as TGID, Source and Destination codes for selective calling). Encryption information can be added to protect the voice information, and other digital information can also be transmitted such as a user defined low speed data word or an emergency bit.

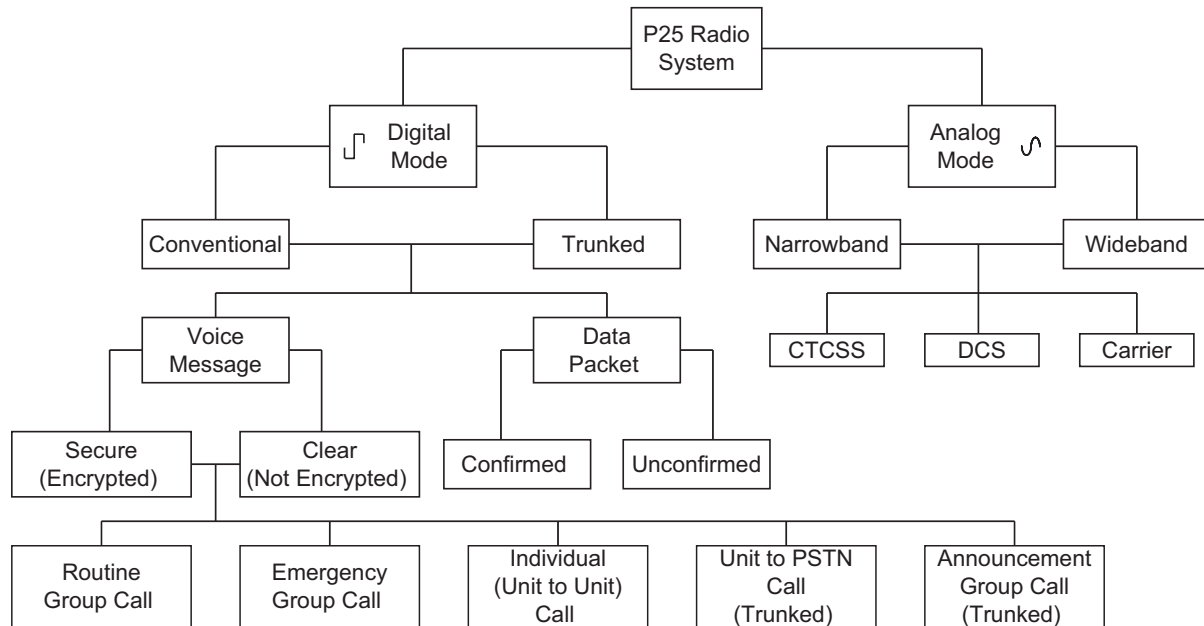

Figure 1-1: P25 Radio System Operation

Figure 1-1 shows the different operational modes of P25 Radio Systems in digital and analog modes.

P25 systems use the Common Air Interface (CAI). This interface standard specifies the type and content of signals transmitted by P25 compliant radios. A P25 radio using the CAI should be able to communicate with any other P25 radio using the CAI, regardless of manufacturer.

Current P25 radios are designed to use 12.5 kHz wide channels, allowing two conversations to take place where only one used to fit (on a 25 kHz channel). In Phase 2, P25 radios will use 6.25 kHz channels, allowing four times as many conversations compared to analog. P25 radios must also be able to operate in analog mode on 25 kHz or 12.5 kHz channels. This backward compatibility allows P25 users to gradually transition to digital while continuing to use older equipment.

P25 transmissions may be protected by digital encryption. The P25 standards specify the use of the Advanced Encryption Standard (AES) algorithm, U.S. Data Encryption Standard (DES) algorithm, and other encryption algorithms. There is an additional specification for over-the-air rekeying (OTAR) to update encryption keys in the radios using the radio network.

P25 channels that carry voice or data operate at 9600 bits per second (bps). These voice or data channels are protected by a substantial amount of forward error correction, which helps receivers to compensate for poor RF conditions and improves useable range.

P25 supports data transmission, either piggybacked with voice (low speed data), or in several other modes up to the full traffic channel rate of 9600 bps.

## P25 RADIO SYSTEM ARCHITECTURE

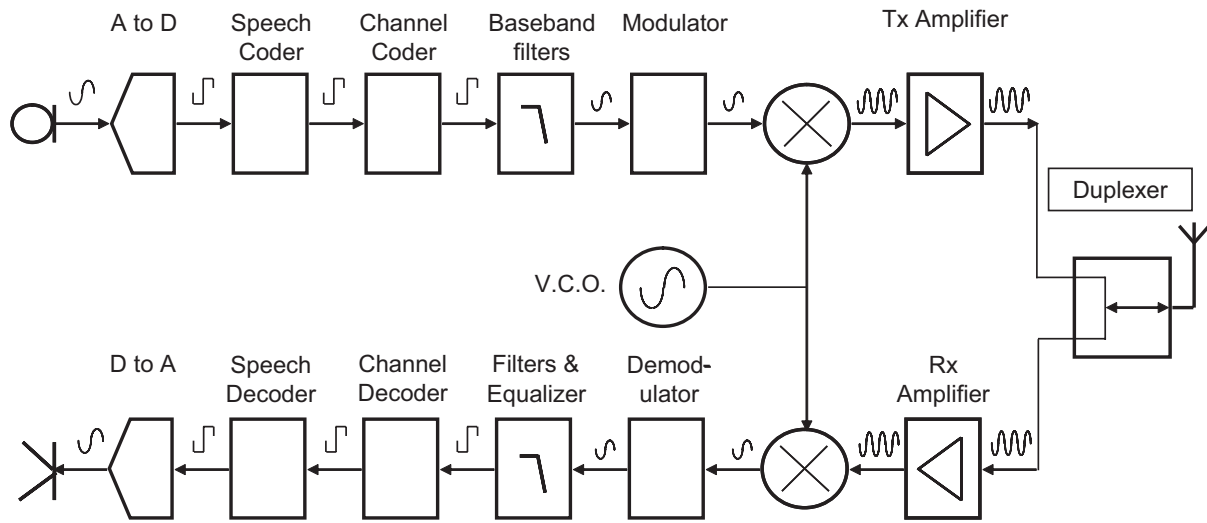

Figure 1-2: P25 Radio System Architecture

Figure 1-2 represents a typical transceiver for digital signals and has been reduced to the basic elements which are specific to digital technology. Hence, things such as multiple stages of IF have been omitted as they are not really relevant to any of the digital technology employed.

The P25 Radio System Architecture can be broken down into three main areas.

### A to D / D to A and Speech Coding / Decoding

P25 uses a specific method of digitized voice (speech coding) called Improved Multi-Band Excitation (IMBE™). The IMBE™ voice encoder-decoder (vocoder) listens to a sample of the audio input and only transmits certain characteristics that represent the sound. The receiver uses these basic characteristics to produce a synthetic equivalent of the input sound. IMBE™ is heavily optimized for human speech and doesn't do very well in reproducing other types of sounds, including dual-tone multifrequency (DTMF) tones.

The IMBE™ vocoder samples the microphone input producing 88 bits of encoded speech every 20 milliseconds. Therefore, the vocoder produces speech characteristics at a rate of 4400 bits per second.

## Channel Coding / Decoding

Channel Coding is the method in which digital RF systems utilize error correction and data protection techniques to ensure that the data (voice or control) arrives and is recovered correctly. The error correction and data protection are designed to improve the system performance by overcoming channel impairments such as noise, fading and interference.

Types of P25 channel coding include interleaving and linear block codes such as Hamming codes, Golay codes, Reed-Solomon codes, Primitive BCH, and shortened cyclic codes.

## Modulating / Demodulating and Filtering

In Phase 1, a 12.5 KHz channel is used to transmit C4FM modulated digital information. C4FM modulation is a type of differential Quadrature Phase Shift Keying (QPSK) where each symbol is shifted in phase by 45 degrees from the previous symbol. Although the phase (frequency) is modulated for C4FM, the amplitude of the carrier is constant, generating a constant envelope frequency modulated waveform.

In Phase 2, digital information is transmitted over a 6.25 KHz channel using the CQPSK modulation format. CQPSK modulates the phase and simultaneously modulates the carrier amplitude to minimize the width of the emitted spectrum which generates an amplitude modulated waveform.

The modulation sends 4800 symbols/sec with each symbol conveying 2 bits of information. The mapping between symbols and bits is shown below:

| Information Bits | Symbol | C4FM Deviation (Phase 1) | CQPSK Phase Change (Phase 2) |
|------------------|--------|--------------------------|------------------------------|
| 01               | +3     | +1.8kHz                  | +135 degrees                 |
| 00               | +1     | +0.6kHz                  | +45 degrees                  |
| 10               | -1     | -0.6kHz                  | - 45 degrees                 |
| 11               | -3     | -1.8kHz                  | -135 degrees                 |

The C4FM modulator is comprised of a Nyquist Raised Cosine Filter, a shaping filter, and an FM modulator.

The CQPSK modulator is comprised of In Phase (I) and Quadrature Phase (Q) amplitude modulators that modulates two carriers. The Q phase is delayed from the I phase by 90 degrees. The filtered output of a 5-level signal, derived from lookup table information, is used to drive the I and Q modulators.

## C4FM Modulator



## CQPSK Modulator

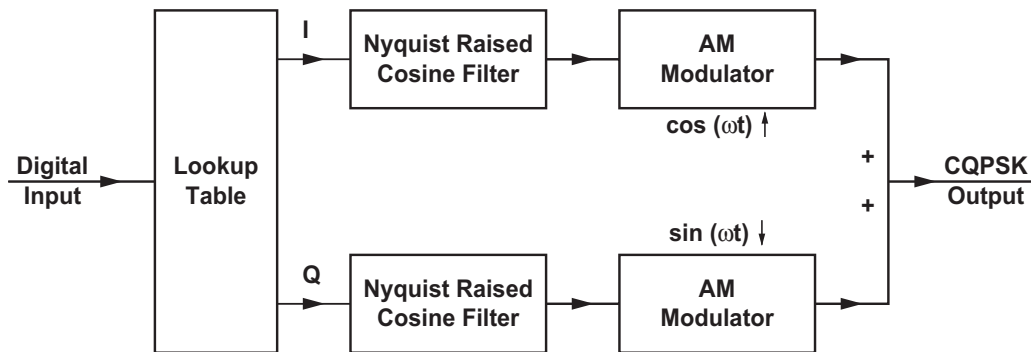

Figure 1-3: C4FM and CQPSK Modulators

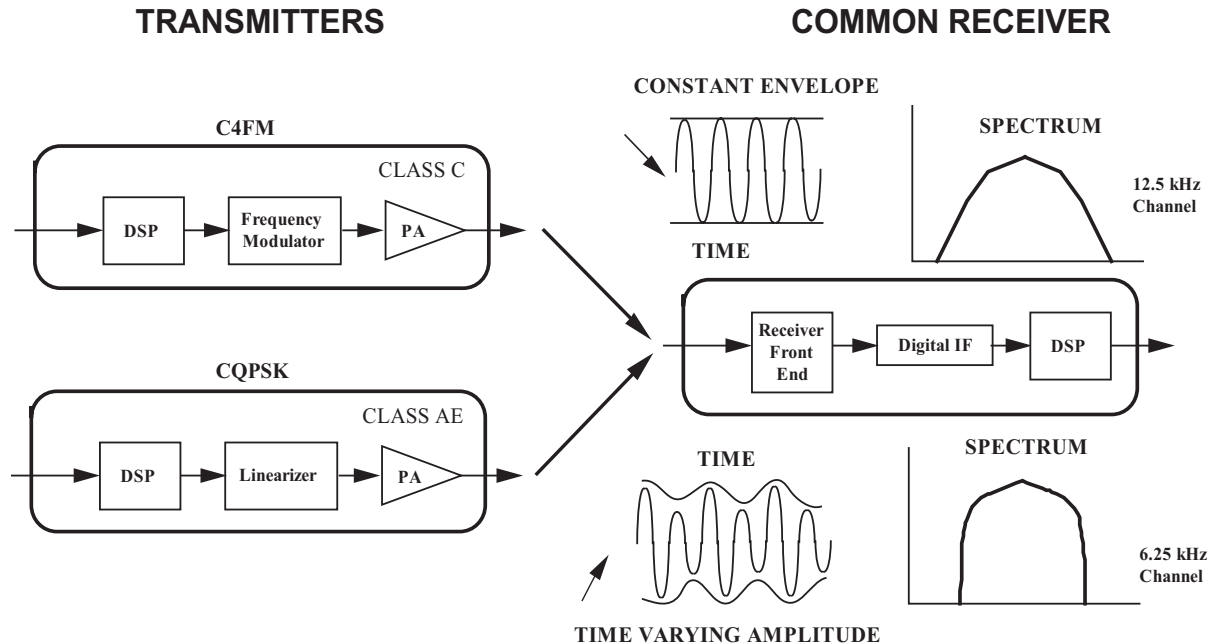

Figure 1-4: QPSK Demodulator (Common Receiver)

The QPSK demodulator is able to receive a signal from either the C4FM modulator or the CQPSK modulator. The frequency modulation detector in the first stage of the demodulator allows a single, Phase 1 demodulator to receive analog FM, C4FM, and CQPSK. The benefit of this is that when migrating to a Phase 2, 6.25 kHz FDMA system, only the transmitter needs to change. The multiple use of the demodulator also means that a Phase 1 receiver can receive analog or digital signals equally well. Phase 2 FDMA equipment is not currently being produced. Phase 2 FDMA will require linear power amplifiers in order to pass the amplitude component of the CQPSK signal. At the present time, linear amplifiers and battery technologies are not developed enough for this use.

## BENEFITS OF P25

P25 has many various benefits in performance, efficiency, capabilities and quality. Some of the key benefits to P25 are as follows:

### Interoperability

Radio equipment that is compatible with P25 standards will allow users from different agencies or areas to communicate directly with each other. This will allow agencies on the federal state/provincial or local level (or any other agency) to communicate more effectively with each other when required (emergencies, law enforcement, etc.)



## Multiple Vendors

The P25 open standard will allow competing products from multiple vendors to be interoperable. This will allow customers of the P25 product to benefit from multiple manufacturing sources (decreased costs, open bidding, non-proprietary systems).

## Backwards Compatibility

A basic requirement for Phase 1 P25 digital radio equipment is backward compatibility with standard analog FM radios. This supports an orderly migration into mixed analog and digital systems, enabling users to gradually trade out radios and infrastructure equipment. By selecting products and systems that comply with P25 standards, agencies are assured that their investment in the latest technology has a clear migration path for the future.

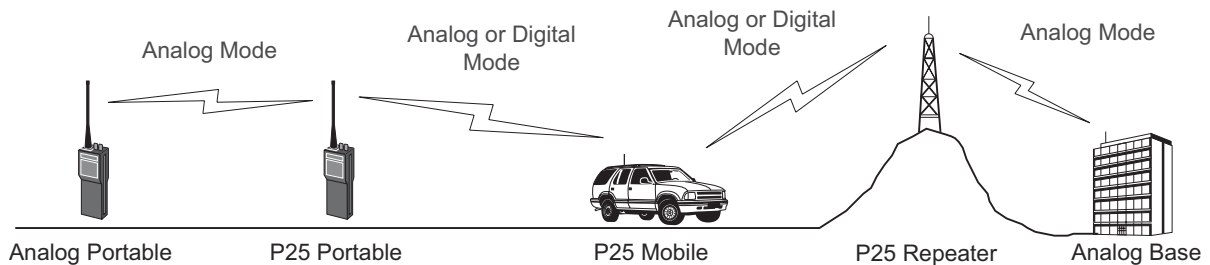

Figure 1-5: P25 Backwards Compatibility

P25 radios operate in analog mode to older analog only radios, and either analog or digital mode to other P25 radios.

Phase 2 P25 radio systems will include a Phase 1 conventional mode for backwards compatibility with Phase 1 P25 equipment.

## Encryption Capability

The P25 standard includes a requirement for protecting digital communications (voice and data) with encryption capability. The encryption used in P25 is optional, allowing the user to select either clear (un-encrypted) or secure (encrypted) digital communication methods. The encryption keys also have the option of being re-keyed by digital data over the RF links. This is referred to as Over The Air Re-keying (OTAR). This capability allows the radio systems manager to change encryption keys without having the subscribers physically bring the radios back to a service shop.

## Spectrum Efficiency

P25 maximizes spectrum efficiency by narrowing bandwidths.

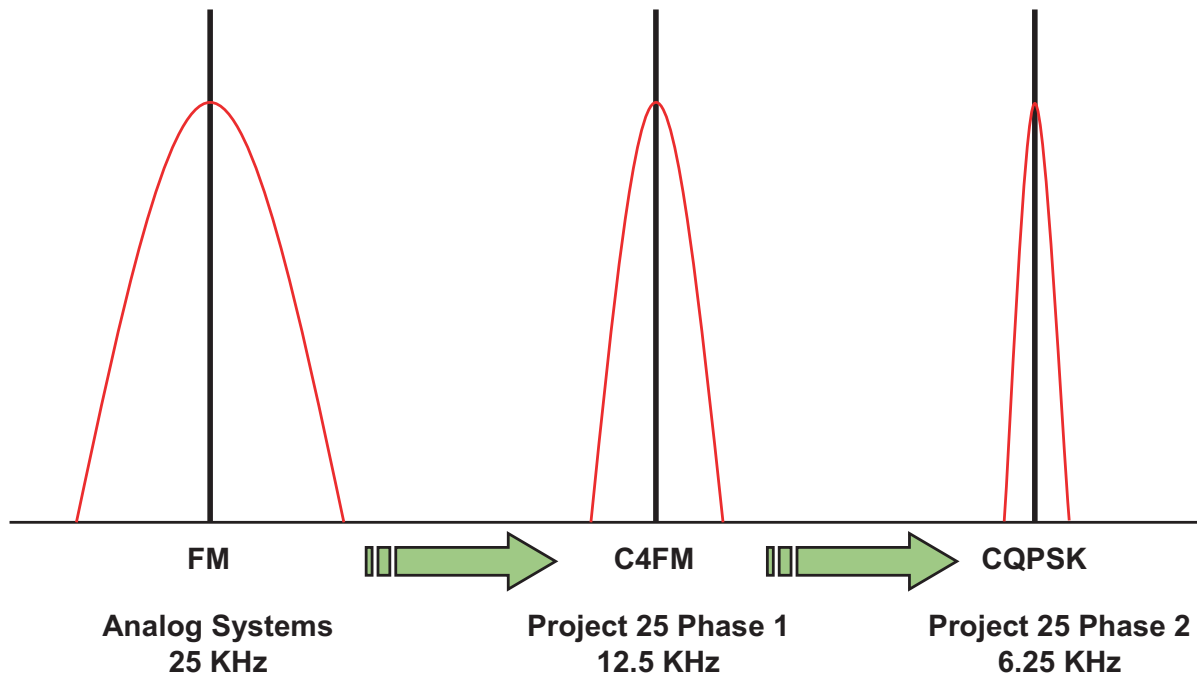

Figure 1-6: P25 Spectrum Efficiency

The RF spectrum is a finite resource used by every country in the world. Spectrum efficiency frees up more channels for radio system use.

## Improved Audio Quality

With more than one quarter of the channel capacity used for error correction, P25 digital signals have greatly improved voice quality over standard analog signals, especially at low or noisy RF carrier levels. The IMBE™ voice coder converts voice information into digital data and then the data is protected using error correction codes. The error correction is able to correct for small errors in the received signal. Since the audio is digitally encoded the background noise typically present in analog systems is also removed.

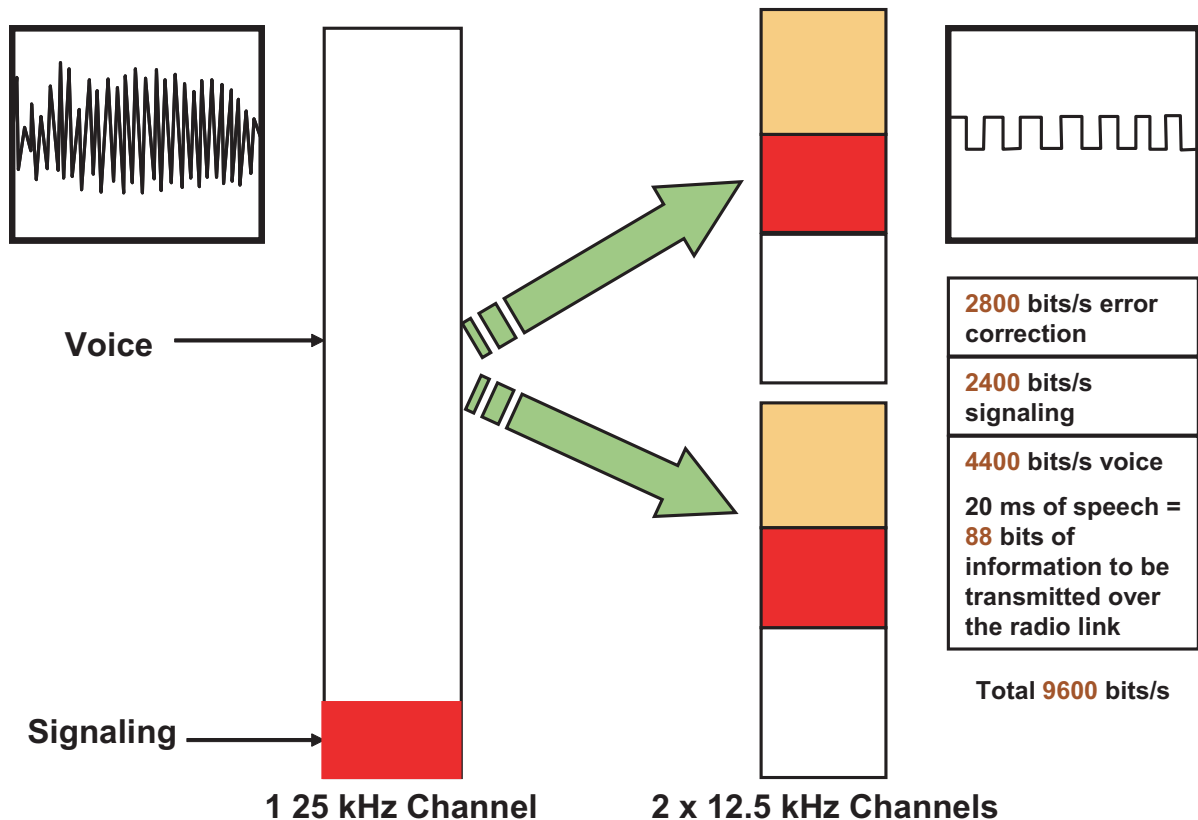

Figure 1-7: Analog to P25 Channel Comparison

## Enhanced Functionality

P25 radio systems use 2400 bits per second for signaling capabilities. This allows a vast array of additional functions and features to be standard in any P25 radio system. The signaling capabilities include selective calling (Source and Destination ID), talk groups (TGID), network (repeater) access codes (NAC) and emergency flags all as standard P25 digital features.

P25 signaling also allows for Manufacturers ID's which will allow different manufacturers to customize radio capabilities, Low Speed Data for user applications, encryption keys and algorithms for secure transmission and many other standard signaling formats.

## OTHER DIGITAL STANDARDS

Although P25 is the focus of this document, it is important to understand that there are many different digital radio standards in use around the world. P25 has primarily been adopted for use in North America, while another leading digital standard, TETRA (Terrestrial Trunked Radio) has primarily been adopted for use in Europe.

While P25 and TETRA appear to be the two leading digital Land Mobile Radio standards in the world today, there are other digital, spectrally-efficient radio systems that have been submitted to the International Telecommunication Union's Radiocommunication Sector's (ITU-R) Study Group 8 and its Working Party 8A.

ITU-R is charged with determining the technical characteristics and operational procedures for a growing range of wireless services. The Radiocommunication Sector also plays a vital role in the management of the radio-frequency spectrum. Study Group 8 and its Working Party 8A is responsible for studies related to the land mobile service, excluding cellular, and to the amateur and amateur-satellite services.

Digital radio systems can operate using different channel access methods such as FDMA (Frequency Division Multiple Access), TDMA (Time Division Multiple Access), or other methods (FHMA - Frequency Hopping Multiple Access).

Project 25, Tetrapol, and EDACS® (Enhanced Digital Access Communications System) Aegis™ are three different FDMA systems. TETRA, DIMRS (Digital Integrated Mobile Radio System), and IDRA (Integrated Digital Radio) are three different TDMA systems.

### Project 25

The United States submitted Project 25 to ITU-R Working Party 8A. It includes a family of two modulation methods, C4FM and CQPSK. C4FM fits within a 12.5 kHz channel mask and uses constant-envelope modulation (i.e., does not require a linear or linearized amplifier). CQPSK fits within a 6.25 kHz channel mask but does require the use of either a linear or linearized amplifier. Both trunked and conventional (non-trunked) operation is provided for.

### Tetrapol

France submitted Tetrapol to ITU-R Working Party 8A. It uses a constant-envelope modulation technique that fits within a 10 kHz channel mask. Systems are in use in a number of countries in Europe and around the world. EADS is the principal manufacturer of this equipment.

## EDACS® Aegis™

L.M. Ericsson AB (with support from the Swedish Administration) submitted EDACS® Aegis™ to ITU-R Working Party 8A. It uses a constant-envelope modulation technique and has four different selectable levels of deviation and filtering that can result in the signal fitting within 25 kHz and 12.5 kHz channel masks. Systems are in use in a number of countries around the world. M/A-COM, Inc. is the principal manufacturer of this equipment.

## TETRA

A number of European countries submitted TETRA to ITU-R Working Party 8A on behalf of ETSI (the European Telecommunication Standards Institute). TETRA's primary mode uses  $\pi/4$ DQPSK modulation that requires a linear or linearized amplifier and fits four-slot TDMA within a 25 kHz channel mask.

## DIMRS

Canada submitted DIMRS to ITU-R Working Party 8A. It is a six-slot TDMA system using 16QAM modulation that fits within a 25 kHz channel mask. It is designed primarily for public systems and is in use in a number of countries around the world. Motorola Inc. is the principal manufacturer of this equipment, under the name IDEN™.

## IDRA

Japan submitted IDRA to ITU-R Working Party 8A. It also is a six-slot TDMA system using 16QAM (16 point Quadrature Amplitude Modulation) that fit within a 25 kHz channel mask. A major difference from DIMRS is the use of a different vocoder.

## FHMA

Israel submitted FHMA to ITU-R Working Party 8A. The system primarily makes use of frequency hopping and sectorized base station antennas to gain spectrum efficiency. The signals are heavily error protected and when a radio is at a sector boundary, due to different frequency hop patterns between sectors, interference to and from nearby radios in the other sector is minimized. Geotek Inc., a U.S. company, was the principal manufacturer of this equipment before the company went bankrupt.

Although the other digital standards seem to work well for their original intentions, APCO felt that these standards would not meet all of the requirements for a public safety agency within North America. P25 standards were designed primarily for the public safety user, with range and performance given very high priority. Also, unique flexibility has been designed into the standards to enhance interoperability, privacy, gradual phase-in of new technologies, and the reliable transmission of voice and data.

## P25 PARTICIPANTS

P25 includes a number of participants both in the public and private sectors.

### PUBLIC SECTOR

|  |   |
|--|---|
| American Association of Railroads (AAR)                            | State of Nevada Department of Public Safety           |
| APCO Canada  | New York State Police                                 |
| APCO International   | New Jersey State Police Communications                |
| British APCO (BAPCO)   | State of Oklahoma                                     |
| British Home Office  | Orange County (California) Division of Communications |
| Defence Research Agency (UK)                                       | Peel Regional Police Systems (Canada)                 |
| State of California Division of Telecommunications                 | San Bernardino County (California)                    |
| State of Colorado Communications                                   | Suffolk County (New York) Police Department           |
| State of Delaware  | State of Utah   |
| Federal Bureau of Investigation (U.S.)                             | Commonwealth of Virginia EMS                          |
| Federal Communications Commission (U.S.)                           | Commonwealth of Virginia State Police                 |
| State of Florida Division of Telecommunications                    | State of Washington Division of Telecommunications    |
| State of Georgia Division of Communications                        | State of Wyoming Division of Telecommunications       |
| Houston (Texas) Police Department                                  | Telecommunications Industry Association (TIA)         |
| Illinois State Toll Highway Authority                              | University of California - Berkeley                   |
| Indiana State Police   | U.S. Air Force - Hanscom Air Force Base               |
| International Association of Chiefs of Police (IACP)               | U.S. Army - Fort Monmouth                             |
| State of Kentucky Telecommunications                               | U.S. Coast Guard                                      |
| Lower Merion (Ardmore, Pennsylvania) Township Police               | U.S. Department of Defense                            |
| City of Minneapolis  | U.S. Defense Information Systems Agency               |
| State of Minnesota Department of Transportation                    | U.S. Department of Energy                             |
| State of Montana   | U.S. Department of Treasury                           |
| City of Montreal   | U.S. Drug Enforcement Administration                  |
| National Association of State Telecommunications Directors (NASTD) | U.S. Fish and Wildlife Service                        |
| National Communications System (U.S.)                              | U.S. Forest Service                                   |
| National Institute of Justice                                      | U.S. Immigration and Naturalization Service           |
| National Security Agency (U.S.)                                    | U.S. Marshall Service                                 |
| National Telecommunications and Information Administration (NTIA)  | U.S. Park Police                                      |
| State of Nebraska  | U.S. Secret Service                                   |

## PRIVATE SECTOR

|                                       |                                       |
|---------------------------------------|---------------------------------------|
| ARCON Corporation                     | Maxon                                 |
| AT&T Bell Labs                        | Midland Systems                       |
| Automated Monitoring & Control Int'l  | MITRE Corp.                           |
| Avtec Inc.                            | Modular Communication Systems         |
| Aware Inc.                            | Motorola Inc.                         |
| BK Radio / Relm Communications        | MX COM                                |
| Bosch Telecommunications              | National Communications Systems (NCS) |
| Cable & Wireless Ltd.                 | NTT America                           |
| Clearsoft Inc.                        | OCS Technologies                      |
| Comarco Corp.                         | ORBACOM Systems Inc.                  |
| Communication Technical Asssociations | Phillips Communications               |
| CSX Transportation                    | Quantum Telecommunications            |
| Cycomm Corp.                          | RAM Communications                    |
| Daniels Electronics Ltd.              | Raytheon Service                      |
| Dataradio Inc.                        | RI/ERT                                |
| Digital Voice Systems Inc. (DVSI)     | SafeTran Systems Inc.                 |
| DRA Malvern                           | SCC Corp.                             |
| E. F. Johnson Co.                     | SEA Inc.                              |
| Ericsson                              | Standard Communications Corp.         |
| Garmin International                  | Swan & Associates                     |
| GEC-Marconi                           | Tait Electronics USA Inc.             |
| Glenayre Electronics                  | Technology Communication Systems      |
| GTE Inc.                              | Tektronix Corp.                       |
| Harris Corp.                          | TeleResources PIC                     |
| Hewlett Packard Corp.                 | TeleTec Corp.                         |
| Hitachi Telecommunications Inc.       | Top Tech Group                        |
| Hughes Aircraft Company               | Transcrypt International Inc.         |
| ITT Research Institute                | Union Pacific Railroad                |
| IVHS America                          | Wilkes, Artis, Hedrick & Lane Lawyers |
| Japan Radio Company                   | Zetron, Inc                           |
| Kokusai                               |                                       |

## P25 Worldwide Systems

### Countries with P25 - Interoperable Equipment or Networks

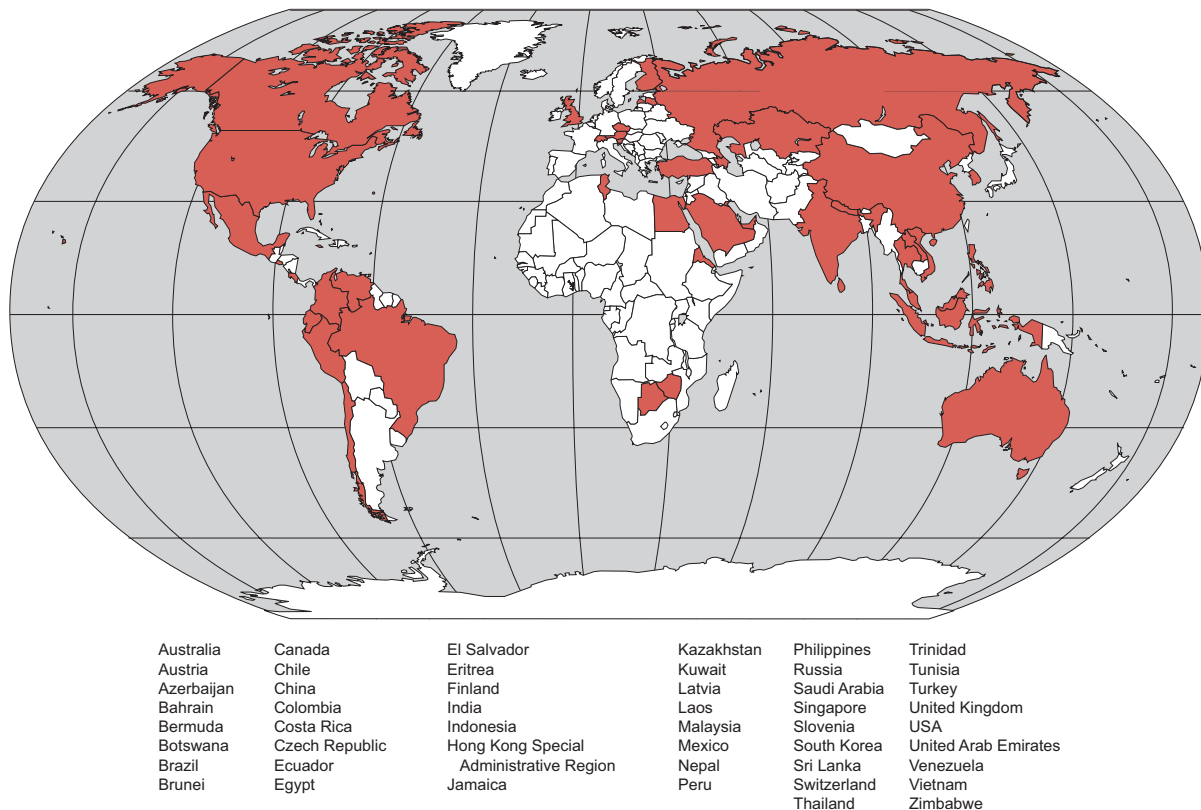

Figure 1-8: P25 Worldwide Participants





## CHAPTER 2: P25 INTERFACE STANDARDS

### P25 STANDARDS – GENERAL SYSTEM MODEL

This section will introduce you to the P25 General System Model and the P25 interface standards that are integral to the P25 radio systems.

There are currently more than thirty technical documents in the Phase 1 set of P25 standards. The Telecommunications Industry Association (TIA) developed these standards. The P25 users continue to enlarge a Statement of Requirements while the industry develops the standards for those requirements and the Project 25 Steering Committee verifies their adherence to the users' needs. The P25 documents have also been approved by the American National Standards Institute (ANSI®) as ANSI® standards. This is the ultimate recognition in the United States of the utility and support of a technology as a standard.

The individual documents describe component interfaces needed to build systems. Depending upon the type of system the user needs, individual documents are available that detail how standardized elements can make up a standardized system. These systems can be trunked or conventional, they can be voice only, data only or voice and data, and they can be clear or encrypted. In essence, manufacturers can build systems that are fully comparable to today's analog systems in function, but are much richer in features.

The P25 standards are contained in the TIA-102 suite of documents. Copies of the standards documents may be purchased through Global Engineering Documents by commercial entities. Public agency users can get a copy of all of the documents on a CD-ROM from the National Communications System (NCS). NCS is the standards arm of the U.S. Department of Defense. Copies may also be obtained from the Department of Justice, National Institute of Justice (NIJ) Standards and Technology Group. NIJ is a primary advocate and supporter of the Project 25 process.

P25 defines seven interfaces to an RF subsystem (RFSS). These are shown in Figure 2-1 the P25 General System Model. Within the RFSS, all equipment is unique to a single manufacturer. An example of a closed interface within the RFSS is the interface between a trunking controller and its base station. Each of the open interfaces shown in Figure 2-1 is defined in a TIA document.

The Inter Subsystem Interface (ISSI), Network Management Interface, Console Interface and Fixed Station Interface are being developed. It is P25's intention to standardize these equipment subsystem interfaces whenever practical. The ISSI, console, and fixed station interfaces are based on the use of Internet Protocol (IP).

The general system model of a P25 compliant digital radio system defines the system elements plus intra-system and inter-system interfaces and naming conventions of these elements and interfaces.

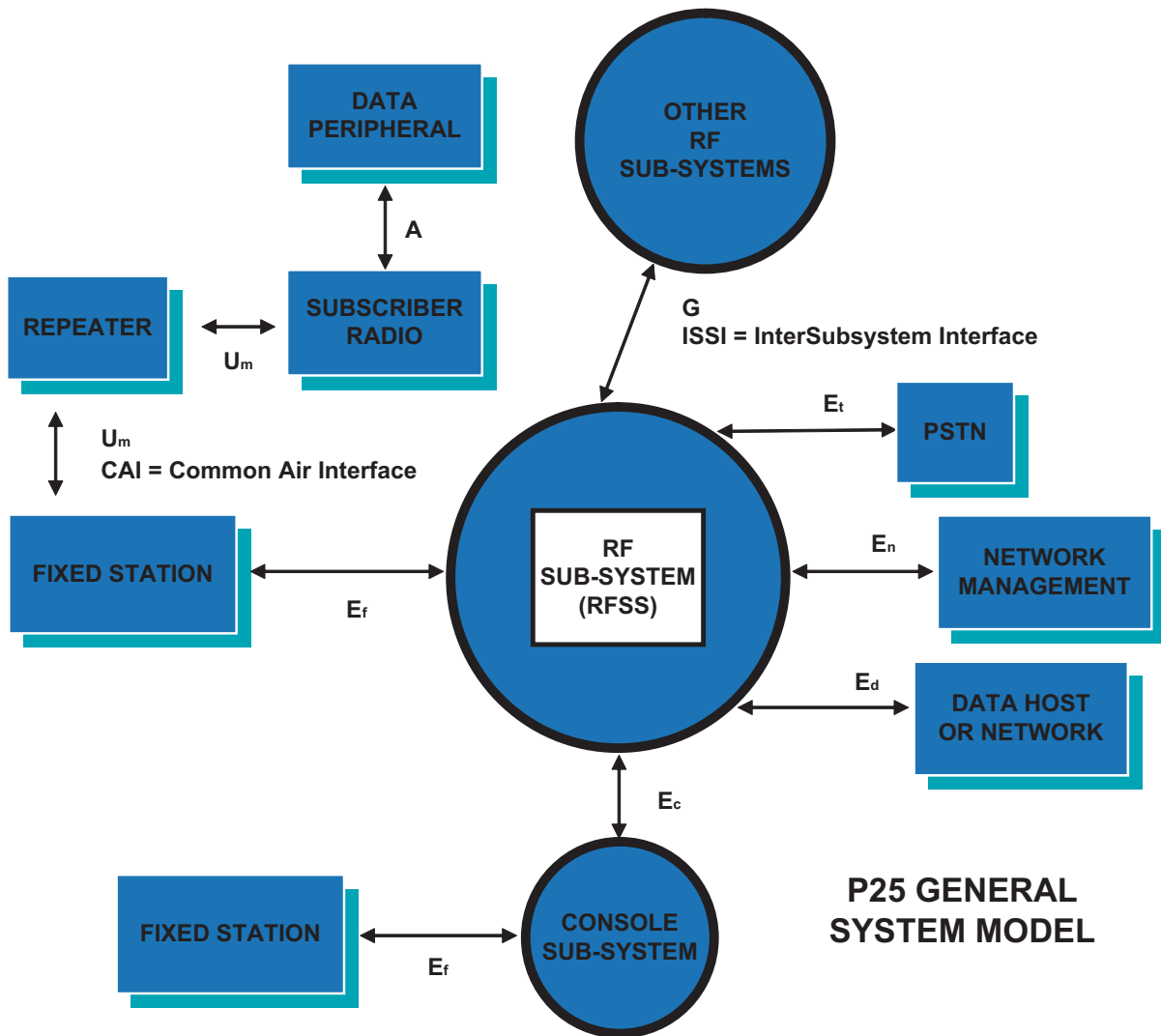

Figure 2-1: P25 General System Model

The P25 Interface Standards as shown on the General System Model are as follows:

|                                       |  |
|---------------------------------------|--|
| RF Sub-System (RFSS)                  | Core Infrastructure  |
| Common Air Interface (Um)             | Radio to radio protocol  |
| Inter-System Interface (ISSlg)        | RFSS to all other system interconnections (In progress)            |
| Telephone Interconnect Interface (Et) | PSTN to RFSS definition  |
| Network Management Interface (En)     | Network to RFSS definition (In progress)                           |
| Data Host or Network Interface (Ed)   | Computer aided dispatch to RFSS definition                         |
| Data Peripheral Interface (A)         | Radio to Data Peripheral definition                                |
| Fixed Station Interface (Ef)          | Base station to RFSS / Console Sub-System definition (In progress) |
| Console Sub-System Interface (Ec)     | Console to RFSS definition (In progress)                           |

## RF SUB-SYSTEM

The P25 interfaces bound the RF Sub-system (RFSS) infrastructure. The RF Sub-system can be made from any collection of site equipment (single station/site or multiple station/site), whose only requirement is that the equipment supports the Common Air Interface, and contains all necessary control logic to support the open intersystem interfaces and call processing. The RF Sub-systems are the building blocks for wide-area system construction and will connect with any other configuration of equipment or RF Sub-systems.

## COMMON AIR INTERFACE

The Common Air Interface (Um) or CAI defines a standard (or reference point) at which communications between P25 radios can take place. The CAI is the core element of the P25 standard that assures the ability of one company's P25 digital radio to communicate with another company's P25 digital radio. Communications between P25 radios are done at a gross bit rate of 9.6 kbps and with FDMA channel access. Several processes take place to convert information for transmission. The Common Air Interface uses an IMBE™ voice coder (vocoder) to convert (compress) speech to a digital format for communication. This voice information is then protected with error correction coding to provide protection over the channel. The voice information and error correction is then transmitted with additional encryption information, unit identification, and low speed data to fully utilize the 9.6 kbps of channel capacity in the Common Air Interface.

A breakdown of the information contained in the Common Air Interface can be found in Chapter 4: Anatomy of the Common Air Interface. Chapter 5 contains some detailed information on the operation and theory of the IMBE™ Vocoder.

## INTER-SYSTEM INTERFACE

The Inter-System Interface (G) is under development.

The Inter-System Interface (G) or ISSI permits multiple RF Sub-Systems to be interconnected together into wide-area networks. The ISSI defines a multi-channel digital interface supporting standard protocols to enable interoperability utilizing mobility management and wide-area service support functionality. The interface is designed to give system designers the flexibility to combine any number of RF Sub-Systems of any size. The Inter-System Interface also provides a common meeting place for RF Sub-Systems of different technologies (TDMA, FDMA, micro-cell) and different RF bands. This interface is optional, and need only be supported when intercommunication amongst and across RFSS's of Land Mobile Radio systems is desired.

Although a P25 subscriber radio may only operate freely among systems with the standard P25 common air interface, the P25 ISSI has the potential to connect between different radio or telecommunications networks as long as they also support the ISSI interface.

The ISSI messaging defines the basic structures to be shared among all equipped RFSS's. The ISSI can be supported on any possible networking configuration, from a simple star configuration to a full mesh, to an intelligent network. This can consist of private links and network support, or may be public links and network support configured as a private network. Any intervening network supporting the information of an ISSI link needs to preserve the ISSI messaging packet, but may intermediately represent the ISSI packet in whatever convenient form (e.g. ATM cell) is available.

The ISSI will support:

- 
- mobility and data management,
- 
- wide area service control,
- 
- service transport,
- 
- end to end protection of signaling information,
- 
- other network interconnection.
-

## TELEPHONE INTERCONNECT INTERFACE

P25 requires an open interface to telephone networks. The Telephone Interconnect Interface (Et) supports both analog and ISDN telephone interfaces, providing for selective use of proven standard telephone interfaces currently in use.

The Telephone Interconnect Interface defines a 2-wire loop start and a 2-wire ground start connection between the RF Subsystem and the PSTN or a PABX. In addition, other optional interfaces may be provided. The Telephone Interface deals only with voice service because it has been assumed that circuit connected data services would access a telephone network via a modem and connect to a data port on the radio system.

## NETWORK MANAGEMENT INTERFACE

The Network Management Interface (En) is under development.

The Network Management Interface defines a network management interface to all RF-Subsystems. According to a single selected network management scheme within any RF-Subsystem, all five classical elements of network management must be supported. It is expected that a network management scheme will be selected that will bring with it the ability to manage RF-Subsystems with available network management system equipment. In addition, an existing network management system, including computer and telecommunications equipment, may well be able to encompass P25 radio systems.

## DATA HOST OR NETWORK INTERFACE

The Data Host or Network Interface (Ed) defines four different types of data connectivity. These include a native open interface for connecting host computers, as well as the requirement to support three different types of existing computer network interfacing (TCP/IP, SNA and X.25).

## DATA PERIPHERAL INTERFACE

The Data Peripheral Interface (A) defines protocols by which mobile and portable subscriber units will support a port through which laptops, terminals, or subscriber unit peripherals may be connected. It is required that the supported open interface protocols are passed transparently into X.25, SNA, or TCP/IP computer networks at another open interface on the fixed equipment side. Transparency is listed as a requirement, and it is expected that application layer standards emerge for the connection of various peripheral devices.

## FIXED STATION INTERFACE

The Fixed Station Interface (Ef) is under development.

The Fixed Station Interface will provide for communication between a Fixed Station (FS) and an RF Sub-System (RFSS) operating in the following modes:

- 
- a. Conventional Analog

---

  - b. Conventional Digital

---

  - c. Trunked Digital

---

  - d. Digital telephone interconnect

---

  - e. Circuit and Packet Data

---

The Fixed Station Interface defines a set of mandatory messages, supporting digital voice, data, encryption and telephone interconnect. These messages will be of a standard format passed over the interface. Manufacturers can enhance this functionality using manufacturer specific messages.

The analog configuration for the fixed station interface are two pairs of signals in a 4-wire audio configuration with both pairs of signals in the audio frequency range 300-3000 Hz. One wire pair carries signals to be transmitted by the FS and the other pair carries signals received by the FS. The circuits are balanced with a nominal 600 ohm impedance. Voice levels of each signal pair are nominally -10 dBm. It is recommended that all inputs and outputs have lightning protection isolation.

The digital configuration for the fixed station interface is an IP based interface. The physical interface is an Ethernet 100 Base-T or 10 Base-T with an RJ-45 connector.

The Fixed Station Interface can also provide several optional analog interfaces as well:

### 2W Circuits

The Fixed Station Interface (analog) may be provided using 2W circuits using a balanced 600 ohm termination.

### E & M Control

The Fixed Station Interface (analog) may include standard E&M signaling circuits.

### Tone Control

The Fixed Station Interface (analog) may provide for remote control using industry standard tone remote control equipment.

## CONSOLE SUB-SYSTEM INTERFACE

The Console Sub-System Interface (Ec) is under development and could possibly be integrated into the Fixed Station Interface in the future.

The Console Sub-System Interface (CSSI) defines a multi-channel digital interface. This interface is capable of supporting standard protocols to enable interoperable support functionality. The CSSI defines basic messaging structures to interface a console subsystem to an RFSS.

The CSSI can be supported using a variety of networking technologies and topologies, from a simple star configuration to an intelligent backbone network. The networks may be private, or public networks configured as private networks.

The physical interface is an Ethernet 100 Base-T with an RJ-45 connector. The CSSI will support Ethernet 10 Base-T and 1000 Base-T as an optional physical interface. The CSSI will optionally support auto-sensing. Other interfaces may be installed as a manufacturer's option.

As a note, a console sub-system can connect directly to a fixed station and support one or more Fixed Station Interfaces. Manufacturers may also optionally support a subset of the Data Host or Network Interface in the Console.







## CHAPTER 3: P25 PRACTICAL APPLICATIONS

### ANALOG TO P25 TRANSITION

P25 equipment can be used in any configuration that is typically found in existing analog systems. Base Stations, remote bases, repeaters, voting, and simulcast systems are all configurations of P25 conventional systems. Transmitter RF power output levels and receiver sensitivity levels of P25 equipment are very similar to those of conventional analog equipment. P25 equipment can therefore be used in a “one-for-one replacement” scenario of analog equipment. This section will discuss some of the issues surrounding the transition from an analog radio system to a P25 digital radio system as well as supply general knowledge about P25 radio systems.

### P25 FREQUENCY BANDS

The frequency bands in which P25 radio systems are available are VHF (136 – 174 MHz) and UHF (403 – 512 MHz, 806 – 870 MHz). In addition, P25, Phase 1 technology has been adopted by the FCC as the digital interoperability standard for the new 700 MHz (746 – 806 MHz) digital public safety band.

## P25 DIGITAL CODE DEFINITIONS

A P25 digital radio system uses many different codes, identifications, indicators and other digital information in the Common Air Interface. Some of the codes are user accessible or programmable, while others are meant for internal use inside of the CAI, or for specific applications.

### Frame synchronization

A special sequence of 48 bits marking the location of the first bit of the message provides frame synchronization. Frame synchronization occurs at the beginning of every message (voice and data), and is inserted every 180 ms throughout the voice message. This allows receivers to pick up voice messages after the message has begun (late entry of receivers). Late entry can occur when a subscriber unit selects a channel (or talk group) while there is already an active signal present. The subscriber unit was not active when the transmission started, but is added when it detects the repeated frame sync function. The frame synchronization is not accessible or programmable by the user.

*(See Chapter 4; Figure 4-3)*

### Network ID (NID)

Every P25 data unit packet contains the 64 bit NID field. The NID is composed of a 4 bit Data Unit ID and a 12 bit NAC code. The NID is protected with a primitive BCH Code and a single parity bit is added to fill out the NID code word to 64 bits.

*(See Chapter 4; Figure 4-3)*

### Data Unit ID

The NID contains the 4 bit Data Unit ID field. The Data Unit ID is used to determine the “type” of packet information (eg. Header Data Unit, Logical Link Data Unit 1, etc.). The Data Unit ID is not accessible or programmable by the user.

*(See Chapter 4; Figure 4-3)*

## Network Access Code (NAC)

The NID contains the 12 bit NAC field. NAC codes are user programmable and are typically used to control network access but may also be used to steer repeater functions. NAC codes are used the same way as an analog CTCSS tone (or DCS code). NAC codes minimize co-channel interference and allow repeater addressing by keeping the receiver squelched unless a signal with a matching NAC arrives.

The NAC code's 12-bit field ranges from hexadecimal \$000 to \$FFF and contains 4096 addresses (significantly more than the standard CTCSS and DCS tones).

The following NAC codes have specific functions:

|       |   |
|-------|---|
| \$293 | specified as the default NAC value.   |
| \$F7E | a receiver set for NAC \$F7E will unsquelch on any incoming NAC.  |
| \$F7F | a repeater receiver set for NAC \$F7F will allow all incoming signals to be repeated with the NAC intact. |

*(See Chapter 4; Figure 4-3)*

## CTCSS to NAC Conversion

Early TIA documents specified a formula for converting analog CTCSS tones and DCS codes to specific NAC codes. Those documents have since been removed and the selection of NAC codes has been left to the user. Some government agencies have defined a conversion table for their own use for translating CTCSS to NAC codes (eg. State of California and others).

Shown below is the early TIA conversion table from CTCSS to NAC codes. These codes were determined by taking the CTCSS frequency and multiplying it by ten, then converting the integer result to a hexadecimal number.

CTCSS to NAC code conversion chart

| CTCSS    | NAC Code | CTCSS    | NAC Code |
|----------|----------|----------|----------|
| 67.0 Hz  | \$29E    | 136.5 Hz | \$555    |
| 69.3 Hz  | \$2B5    | 141.3 Hz | \$585    |
| 71.9 Hz  | \$2CF    | 146.2 Hz | \$5B6    |
| 74.4 Hz  | \$2E8    | 151.4 Hz | \$5EA    |
| 77.0 Hz  | \$302    | 156.7 Hz | \$61F    |
| 79.7 Hz  | \$31D    | 162.2 Hz | \$656    |
| 82.5 Hz  | \$339    | 167.9 Hz | \$68F    |
| 85.4 Hz  | \$356    | 173.8 Hz | \$6CA    |
| 88.5 Hz  | \$375    | 179.9 Hz | \$707    |
| 91.5 Hz  | \$393    | 186.2 Hz | \$746    |
| 94.8 Hz  | \$3B4    | 192.8 Hz | \$788    |
| 97.4 Hz  | \$3CE    | 203.5 Hz | \$7F3    |
| 100.0 Hz | \$3E8    | 206.5 Hz | \$811    |
| 103.5 Hz | \$40B    | 210.7 Hz | \$83B    |
| 107.2 Hz | \$430    | 218.1 Hz | \$885    |
| 110.9 Hz | \$455    | 225.7 Hz | \$8D1    |
| 114.8 Hz | \$47C    | 229.1 Hz | \$8F3    |
| 118.8 Hz | \$4A4    | 233.6 Hz | \$920    |
| 123.0 Hz | \$4CE    | 241.8 Hz | \$972    |
| 127.3 Hz | \$4F9    | 250.3 Hz | \$9C7    |
| 131.8 Hz | \$526    |          |          |

## Status Symbols

Throughout the Data Units, 2 bit status symbols are interleaved so that there is one status symbol for every 70 bits of information. The status symbols allow repeaters to indicate the status of the inbound channels to subscribers. The repeaters assert the status symbols on both voice and data messages, indicating inbound activity for both voice and data calls.

The subscribers set the value of the status symbol to signify an Unknown status in their messages since they are unable to indicate the status of any inbound channel.

There are 4 possible values for the status symbol; 01 (for busy), 11 (for idle), 00 (unknown, used by talk-around) and 10 (unknown, used for inbound or outbound). Repeaters use status symbols 01 and 11, and subscribers use status symbols 00 and 10.

There is one value for Busy (01), one for Idle (11), and two values to indicate Unknown status. When the subscriber sends a message on a direct channel, it will use the Unknown value for direct mode operation (00). When the subscriber sends a message inbound to a repeater, it will use the Unknown value for repeater operation (10).

The reference oscillator stability for repeaters and base stations is often better than for subscriber radios. Subscribers may compare the frequency of their local reference oscillator with the carrier frequency from a repeater or base station transmitter, in order to adjust and improve their local reference oscillator. This adjustment is called Automatic Frequency Control (AFC). AFC operation is anticipated by the FCC regulations for the 746-806 MHz band. Subscribers may detect a repeater or base station transmission by checking the values of the status symbols on slot boundaries. A repeater or base station will transmit Busy or Idle indications on slot boundaries. When a subscriber detects these values, it can average enough data symbols from a transmission to obtain an estimate of the carrier frequency used by the repeater or base station. It can then compare this to the receiver local oscillator to determine any frequency corrections to improve local reference stability. After the repeater or base station stops transmitting, the subscriber units will be in an unlock state. AFC locking resumes when a repeater or base station restarts its transmissions.

Status Symbols are not widely used at this time, however there are many possible uses for them in the future (such as data / voice priority).

*(See Chapter 4; Figure 4-3)*

## Manufacturer's ID (MFID)

The Header Code Word and Link Control Word (LDU1) contain the 8 bit MFID field. When the manufacturer uses non-standard (data only) features, the MFID is asserted. When all of the other information fields conform to the Common Air Interface definitions, the MFID has a standard value of \$00 or \$01. A P25 radio must, as a minimum, transmit or receive messages using the the standard values for the MFID field. As a minimum, a P25 receiver will ignore messages which do not contain the standard values for the MFID field. Every manufacturer is assigned an MFID that can be used for proprietary signaling. Non-standard data from one manufacturer may not pass through another manufacturers repeater system.

The MFID's that have been assigned are:

|      |  |
|------|--|
| \$10 | Relm / BK Radio                          |
| \$20 | Cycomm                                   |
| \$28 | Efratom Time and Frequency Products, Inc |
| \$30 | Com-Net Ericsson                         |
| \$38 | Datron                                   |
| \$40 | Icom                                     |
| \$48 | Garmin                                   |
| \$50 | GTE                                      |
| \$55 | IFR Systems                              |
| \$60 | GEC-Marconi                              |
| \$68 | Kenwood Communications                   |
| \$70 | Glenayre Electronics                     |
| \$74 | Japan Radio Co.                          |
| \$78 | Kokusai                                  |
| \$7C | Maxon                                    |
| \$80 | Midland                                  |
| \$86 | Daniels Electronics Ltd.                 |
| \$90 | Motorola                                 |
| \$A0 | Thales                                   |
| \$A4 | M/A-COM                                  |
| \$B0 | Raytheon                                 |
| \$C0 | SEA                                      |
| \$C8 | Securicor                                |
| \$D0 | ADI                                      |
| \$D8 | Tait Electronics                         |
| \$E0 | Teletec                                  |
| \$F0 | Transcrypt International                 |

(See Chapter 4; Figure 4-4 and Figure 4-6)

## Algorithm ID (ALGID)

The Header Code Word and Encryption Synchronization (LDU2) contain the 8 bit ALGID field. The ALGID identifies the encryption algorithm used in the P25 system. The ALGID is entered through a Key Management Facility or Key Loader when entering encryption keys.

The ALGID's that have been defined for Type 1 algorithms are:

|      |   |
|------|---|
| \$00 | ACCORDION 1.3                                 |
| \$01 | BATON (Auto Even)                             |
| \$02 | FIREFLY Type 1                                |
| \$03 | MAYFLY Type 1                                 |
| \$04 | SAVILLE                                       |
| \$41 | BATON (Auto Odd)                              |
| \$80 | Unencrypted message (no encryption algorithm) |
| \$81 | DES-OFB encryption algorithm                  |
| \$82 | 2-key triple DES encryption algorithm         |
| \$83 | 3-key triple DES encryption algorithm         |
| \$84 | AES encryption algorithm                      |

*(See Chapter 4; Figure 4-4 and Figure 4-7)*

## Key ID (KID)

The Header Code Word and Encryption Synchronization (LDU2) contain the 16 bit KID field. The KID identifies the specific encryption key for use when multiple encryption keys have been loaded into the encryption modules. The KID is also used for single encryption key systems. The typical default KID for clear or secure systems is \$0000. The KID is entered through a Key Management Facility or Key Loader when entering encryption keys.

*(See Chapter 4; Figure 4-4 and Figure 4-7)*

## Message Indicator (MI)

The Header Code Word and Encryption Synchronization (LDU2) contain the 72 bit MI field. The MI is the initialization vector (synchronization for key stream generator) for a Type 1, Type 2, Type 3 or Type 4 encryption algorithm. Clear messages are denoted \$00000000 while secure (encrypted) messages are variable. The Message Indicator is not accessible or programmable by the user.

*(See Chapter 4; Figure 4-4 and Figure 4-7)*

## Talk-group ID (TGID)

The Header Code Word and Link Control Word (LDU1) contain the 16 bit TGID field. The TGID identifies the talk-group for the message. The purpose of a talk group is to allow logical groupings of radio users into distinct organizations. The TGID could also be used to minimize co-channel interference and allow subscriber addressing.

The TGID ranges from hexadecimal \$0000 to \$FFFF and contains 65,536 addresses.

The following TGID's have specific functions:

---

\$0001 specified as the default TGID value and should be used in systems where no other talk groups are defined.

---

\$0000 no-one or a talk group with no users. Used when implementing an individual call.

---

\$FFFF reserved as a talk group which includes everyone.

---

*(See Chapter 4; Figure 4-4 and Figure 4-6)*

## Low Speed Data

Each Logical Link Data Unit in a voice message contains the 16 bit Low Speed Data field. The Low Speed Data is intended for custom user applications not defined by the CAI (possibly GPS location data, infrastructure status information, etc.) and has a total capacity of 88.89 bps. The Low Speed Data is encoded with a shortened cyclic code to create 64 bits per superframe.

*(See Chapter 4; Figure 4-6 and Figure 4-7)*



## Unit ID

The Unit ID is a 24 bit user programmable field that is used for both group and individual calling. The Unit ID is used as both a Source ID (from the sending unit) and a Destination ID (in the receiving unit in an individual call).

The Unit ID ranges from hexadecimal \$000000 to \$FFFFFF and contains 16,777,216 addresses. The Unit ID's should be programmed into the radios using a national, corporate or agency wide unit identification scheme.

The following Unit ID's have specific functions:

|                       |   |
|-----------------------|---|
| \$000000              | no-one. This value is never assigned to a radio unit                  |
| \$000001 to \$98967F  | for general use.  |
| \$989680 to \$FFFFFFE | for talk group use or other special purposes.                         |
| \$FFFFFFF             | designates everyone. Used when implementing a group call with a TGID. |

## Source ID

The Link Control Word (LDU1) contains the 24 bit Source ID field. The Source ID is the Unit ID of the SENDING unit. The Source ID is typically sent in all voice messages and is used for both group and private calling.

*(See Chapter 4; Figure 4-6)*

## Destination ID

The Link Control Word (LDU1) contains the 24 bit Destination ID field. The Destination ID is used for private voice messages only (called private or individual calling). The Destination ID is the Unit ID of the intended recipient of the individual call.

*(See Chapter 4; Figure 4-6)*

## Emergency indicator

The Link Control word (LDU1) contains the 1 bit Emergency indicator field. The Emergency indicator is embedded in group voice messages to indicate an emergency condition.

The emergency indicator bit is designed to be selectable by a switch or programming in the subscriber units. The emergency indicator bit can be set as follows:

|   |                                  |
|---|----------------------------------|
| 0 | routine, non-emergency condition |
| 1 | emergency condition              |

(See Chapter 4; Figure 4-6)

## Link Control Format

The Link Control Format is an 8 bit field contained in the Link Control Word (LDU1). The Link Control Format is used to specify content of the Link Control Word. The Link Control Format is not accessible to the user.

(See Chapter 4; Figure 4-6)

## Packet Data Unit

There are other digital codes used in the Packet Data Unit such as the Service Access Point (SAP), Full Message Flag (FMF), etc. These digital codes will not be defined in this document.

## P25 VOICE MESSAGE OPTIONS

P25 Radio Systems can perform voice messages in a variety of ways or modes. P25 radio systems will operate in both P25 digital mode and conventional analog mode. Voice messages can be sent over a 12.5 KHz bandwidth analog channel using standard analog call procedures with analog signaling (CTCSS, DCS, etc.). Some manufacturers also have equipment that will allow operation in 25 KHz analog bandwidth.

P25 voice messages can also be sent in P25 digital mode. P25 voice messages can be sent in either encrypted (secure) or unencrypted (clear) mode. The secure / clear operation is typically an option that is required to be installed in the subscriber units.

There are 3 main ways to send a voice message, with several options and variations of each case. Each of these 3 main ways to send a voice message can operate in clear or secure mode.

The three main types of voice message calls are:

|                      |  |
|----------------------|--|
| Routine Group Call   | This is the most common type of call and is intended for a group of users within the radio system. This type of call is typically initiated by asserting the PTT switch.   |
| Emergency Group Call | This type of call is similar to a Routine Group Call, but is used during an emergency condition. An emergency condition is defined by the radio system users. This type of call is typically initiated by asserting the Emergency switch.                                      |
| Individual Call      | This type of call is addressed to a specific individual. The caller enters the subscribers Unit ID, that they wish to call, and this is used as the Destination ID by the radio making the call. This type of call is made after the Destination ID is entered into the radio. |

The P25 transmitter has sufficient controls to support the three main types of voice messages. These controls are as follows:

**PTT Switch** - The Push-To-Talk switch is pressed when the user wishes to transmit and released when the transmission is over.

**Channel Selector** - The Channel Selector allows the user of the radio to select a radio's mode of operation. The Channel Selector controls the following parameters of the radio:

1. Frequency
2. NAC
3. TGID
4. Other (eg. selecting the encryption key)

**Emergency Switch** - The Emergency switch will allow the user to assert the emergency condition. Once asserted, the emergency condition remains active until cleared by some other means (eg. turning the radio off).

**Numeric Keypad / Display** - The Numeric Keypad / Display will allow the user to set numeric parameters (eg. the Destination ID in an individual call).

#### Routine Group Call Procedure

---

- NAC and TGID are set by the user (Channel Selector).
  - MFID is set to standard value for CAI transmission.
  - MI, ALGID, and KID are set by secure or clear mode parameters.
  - Emergency bit is set to indicate non-emergency call.
  - Source ID is the Unit ID of the radio.
- 

#### Emergency Group Call Procedure

---

- NAC and TGID are set by the user (Channel Selector).
  - MFID is set to standard value for CAI transmission.
  - MI, ALGID, and KID are set by secure or clear mode parameters.
  - Emergency bit is set to indicate an emergency call.
  - Source ID is the Unit ID of the radio.
- 

#### Individual Call Procedure

---

- The Unit ID of the user to be called is entered into the radio and this is the Destination ID.
  - TGID is set to the null talk group of \$0000
  - NAC is set by the user (Channel Selector).
  - MFID is set to standard value for CAI transmission.
  - MI, ALGID, and KID are set by secure or clear mode parameters.
-

## P25 ENCRYPTION

The IMBE™ vocoder produces a digital bit stream that is relatively easy to encrypt. Major advantages of the P25 encryption design are that encryption does not affect speech intelligibility nor does it affect the system's usable range. Both of these advantages are major improvements over encryption previously used in analog systems.

Encryption requires that both the transmitting and the receiving devices have an encryption key, and this key must be the same in each unit. This may be done using a Key Loader. Most P25 subscriber equipment is optionally available with the capability of storing and using multiple keys. That is, a unit could use one key for one group of users and use a separate key for another group of users. System management of keys may be done in a Key Management Facility, or KMF.

In the U.S. there are four general "types" of encryption algorithms. Type 1 is for U.S. classified material (national security), Type 2 is for general U.S. federal interagency security, Type 3 is interoperable interagency security between U.S. Federal, State and Local agencies, and Type 4 is for proprietary solutions (exportable as determined by each vendor and the U.S. State Department). The CAI supports use of any of the four types of encryption algorithms. P25 documents currently standardize two different Type 3 encryption processes. One encryption process is the U.S. Data Encryption Standard, or DES algorithm, which uses 64 bit Output Feed Back and is denoted as DES-OFB. Another encryption process is the Advanced Encryption Standard (AES) which is a 256 bit algorithm.

P25 also includes a standardized Over The Air Rekeying (OTAR) function. OTAR is a way to greatly increase the utility of encryption systems by allowing transfer of encryption keys via radio. This remote rekey ability, controlled from a Key Management Facility, or KMF, means that radios no longer have to be physically touched in order to install a new or replacement key into a radio. OTAR signaling is sent as Packet Data Units over the Common Air Interface.

Optionally, multiple encryption keys can be stored in P25 radio equipment. In order to identify the keys, they are stored with an associated label called a Key Identifier or KID. The type of algorithm to be used with the key is identified by an Algorithm ID or ALGID.

To be able to decrypt messages, the receiver decryption module must be in the same state as the transmitter encryption module. The CAI provides space for up to 72 bits of this synchronization information in the Message Indicator (MI) vector at the beginning of the message (in the header), and periodically during the message in the LDU2 portion of the voice superframe.

AES and DES encryption solutions were tested and verified by an accredited National Institute of Science and Technology (NIST) laboratory as compliant with the security requirements of the Federal Information Processing Standard (FIPS).

## ANALOG VS. P25 DIGITAL COVERAGE

There is much discussion about the RF coverage area of an analog radio signal versus a digital radio signal. In theory, a P25 digital radio signal will allow for a slightly greater coverage area when placed in the same location as an analog radio. There are some factors, however, that may interfere with the digital signal to a greater degree than the interference to an analog signal.

P25 Phase 1 uses C4FM modulation. Because C4FM is a constant amplitude modulation, it allows use of nonlinear power amplifiers. Use of nonlinear amplifiers results in digital equipment that produces RF power levels that are equal to the power levels of current analog equipment. This means that systems can be implemented with little or no loss of coverage. This is so because an analog transmitter can be replaced with a P25 Phase 1, digital transmitter that produces the same transmitter output level of the analog transmitter. This is currently not necessarily true for higher power analog systems that are replaced by some TDMA systems when bandwidth of the resultant signal is a critical issue.

In order to occupy a limited bandwidth, some TDMA systems use modulations that require linear power amplifiers and system transmitter power in these systems can be a significant issue. GSM™, for example, uses a 200 kHz wide channel for 8 voice slots, and uses the fixed amplitude GMSK modulation. TETRA on the other hand, uses 4 slots in a 25 kHz wide channel, and TETRA uses DQPSK that contains amplitude and phase components to the modulation. Using a linear amplifier, the variable amplitude modulation implementations produce a relatively lower output power. Their higher data rate also tends to limit the coverage area because of the bit rate and the resultant bit timing. This can result in a much larger infrastructure to support TDMA systems as opposed to the Phase 1 FDMA systems. FDMA also promotes use of a very reliable direct mode of operation because of the power levels of subscriber equipment and the lack of a requirement for any supporting infrastructure. This direct, or talk around, mode insures reliable unit-to-unit operation without the need for any infrastructure. Again, because of the use of non-linear power amplifiers, portable and mobile radio transmitter power of P25 digital equipment is comparable to the power level available in current FM analog equipment.

Since the RF power output levels of current FM analog and P25 digital equipment are equal, it would seem that digital coverage and analog coverage are equal. This is not true, as much more of the covered area is usable when sending a P25 digital signal. The signal-to-noise ratio in the subscriber unit is a critical element of analog systems. P25 signals attempt to correct for noise-induced errors, with the built in error correction, so that fringe areas that were not clearly audible in analog systems have a good chance of being loud and clear with P25 digital.

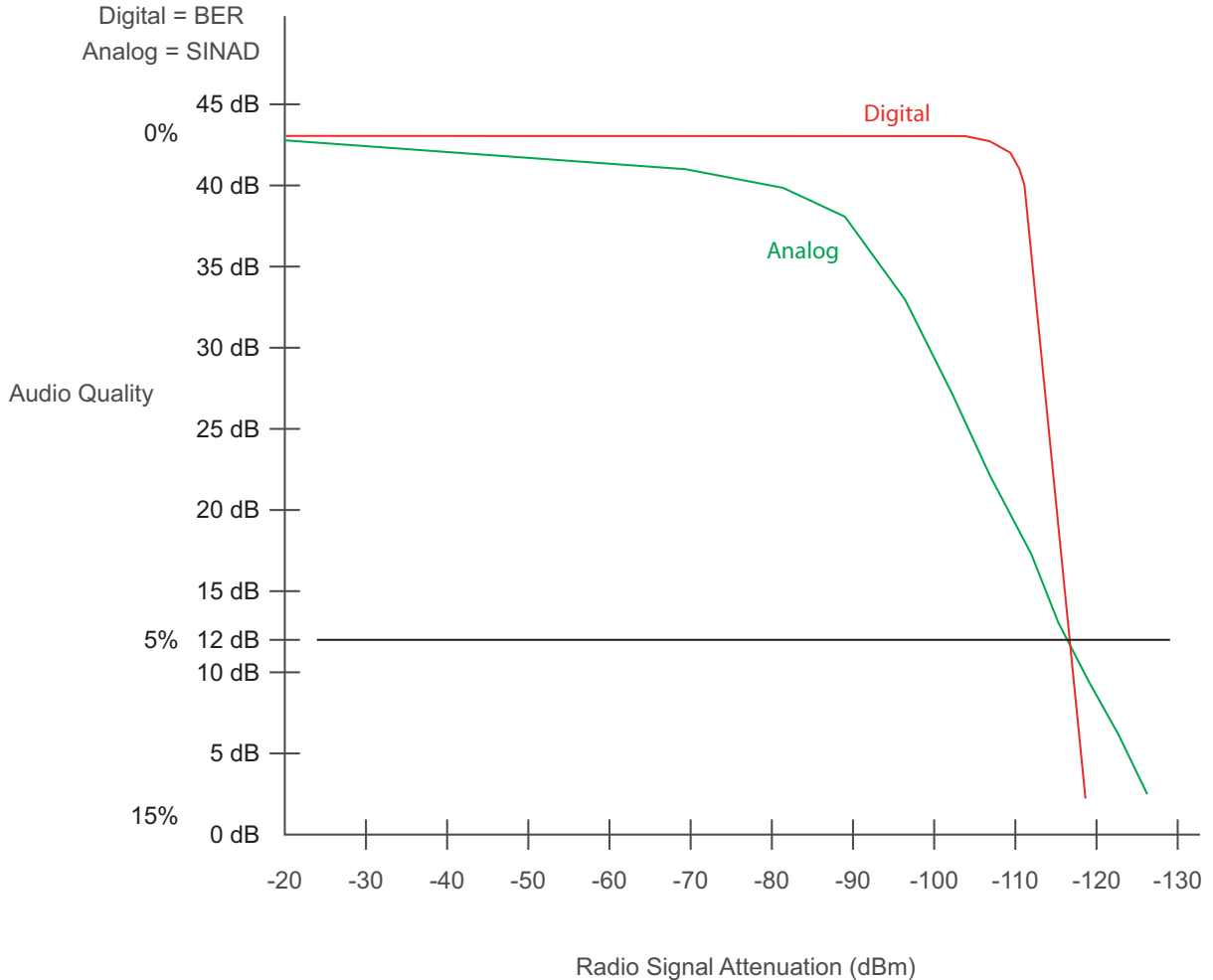

Figure 3-1: Analog vs. Digital Audio Quality

Although it appears that the digital radio signal performs with greater coverage area than an analog radio signal, other factors must also be taken into consideration, such as multipath reflections. Multipath reflections of the RF carrier occurs when two or more signals of the same origin arrive at the receive antenna delayed in time because they traveled different path lengths or because of reflections and scattering in the propagation environment. This deterioration of the signal must be considered when planning coverage areas.

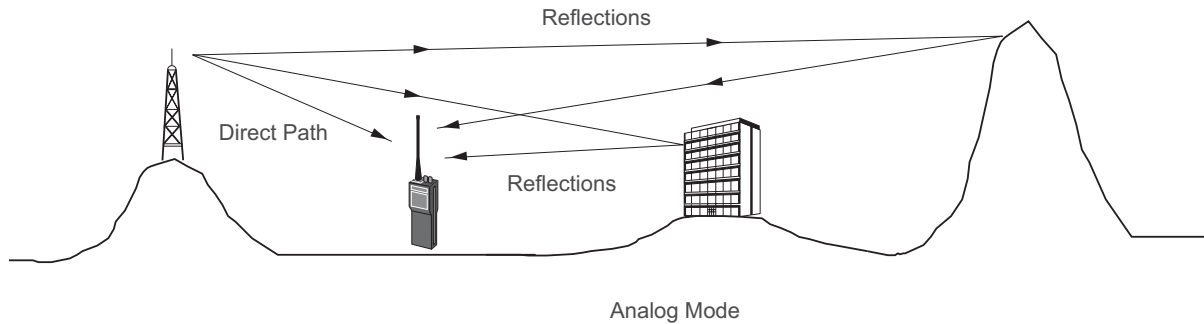

Figure 3-2: The Effects of Multipath

RF multipath is a frequency dependant problem with higher frequencies being more vulnerable. When a subscriber radio is in motion, multipath interference results in the amplitude modulation effect familiar to mobile FM listeners as “picket fencing”. In the worst case, when the subscriber radio is stopped in a signal null, the signal is severely degraded and a single, strong specular reflection may completely cancel the transmitted signal. Where analog reception can become noisy, digital signals could be lost altogether. Increasing power is not a viable remedy because both the direct and reflected signal will increase proportionally, preserving the interference nulls.



## P25 RADIO SYSTEM TESTING

Testing a P25 radio system is very similar to testing an analog system for the majority of tests to be performed. In many cases, the radio system can be tuned in analog mode, and then the accuracy of the digital mode can be tested to ensure compliance.

The following are some radio system tests that can be performed on P25 radio systems in analog or digital mode:

### Analog Receiver Reference Sensitivity

Analog Receiver Reference Sensitivity is a measure of the amount of minimum RF signal level that is required to produce an intelligible audio signal when an FM signal is demodulated. Analog Reference Sensitivity measurements can be made with any P25 receiver in analog mode.

The measurement device used in analog systems is typically the SINAD meter which shows a ratio in dB of:

$$\frac{\text{Signal} + \text{Noise} + \text{Distortion}}{\text{Noise} + \text{Distortion}}$$

### Digital Receiver Sensitivity (BER)

Digital Receiver Sensitivity is a measure of the amount of RF signal level that is required to produce an intelligible audio signal when a C4FM signal is demodulated. Digital Sensitivity measurements can be made with any P25 receiver in digital mode.

Sensitivity in a digital radio system is expressed in terms of Bit Error Rate (BER). BER is the percentage of received bits in error to the total number of bits transmitted. The Digital Sensitivity test must be conducted with a known test signal such as the Standard 1011 pattern. The radio is typically placed into a special test mode for this test and radio specific software and a computer may be required to evaluate a decoded 1011 patterns Bit Error Rate.

### Audio Levels and Distortion

Audio Level and Audio Distortion readings can be performed in both analog mode and digital mode. The measurements are made using the same procedure as for conventional analog equipment. In digital mode, the audio level readings are performed before vocoding in the transmitter, and the audio level and distortion readings are performed after de-vocoding in the receiver.

## Audio Frequency Measurements

FM audio frequency measurement is done with a standard frequency counter. C4FM audio frequency measurements can be made with a standard frequency counter but may appear to be unstable unless the radio is configured to transmit a “LOW DEVIATION PATTERN” as described in the TIA-102.CAAA-A standard.

CQPSK audio frequency measurements must be made through Digital Signal Processing where the signal is decoded and the frequency is calculated. A standard frequency counter is not usable for this type of signal.

## RF Power Measurements (FM and C4FM)

RF Power measurements for Digital C4FM and Analog FM can be made with a standard peak detecting power meter. C4FM digital transmissions are the same as FM transmission in that they are of constant amplitude.

Power measurements for Digital CQPSK cannot be made with a standard power meter. The signal must be decoded through Digital Signal Processing and calculated.

## Analog FM Modulation Accuracy

A deviation meter is used to measure Analog FM Modulation Accuracy. The deviation meter monitors peak carrier movement above and below the carrier center frequency and displays the average offset. Various IF Bandwidth filters are required to ensure accurate measurements.

## Digital Modulation Accuracy (Modulation Fidelity)

Testing Digital Modulation Accuracy can be done using a standard deviation meter or a sampling method.

Measurements can be made with a deviation meter if the radio is configured to a defined test pattern where the radio is transmitting all high or all low bits, however, problems arise because a deviation meter measures only peak deviation and the measurement is not synchronized with the symbols.

The sampling method takes deviation measurements synchronously with the decoded symbol clock and averages the measurements over a group of symbols to calculate a percentage of error. The measured deviation is only important at symbol time. This test may require specific test patterns to be generated from the transmitter.

## Common Air Interface Protocol Testing

CAI Protocol testing requires the ability to decode and encode the 9600 baud data to and from voice and data information. The decoding and encoding capability allows for verification of the radio programming, testing emergency conditions, talk groups, and repeater accessing codes off the air.

## P25 VS. ANALOG DELAY TIMES

Delay times between legacy analog equipment and P25 digital equipment may vary.

In order to understand the different delay times, the following definitions for an analog system are as follows (from TIA-603-C):

### Receiver Attack Time

Receiver attack time is the time required to produce audio power output after application of a modulated input signal.

### Carrier Attack Time

Transmitter carrier attack time is the time required to produce 50% of steady-state carrier output power after changing the state of the transmitter from standby to transmit.

If an analog system uses CCTSS decode and / or encode the following definitions are applicable (from TIA-603-C):

### Receiver Audio Attack Time (CTCSS)

The receiver audio attack time is the elapsed time between the application of a receiver input signal 12 dB above the reference sensitivity modulated with the standard test modulation and standard subaudible modulation, and the time that the audio voltage at the receiver output is greater than 90% of its rated output.

### Encoder Response Time (CTCSS)

The encoder response time is the elapsed time from the moment the push-to-talk control circuit is activated at the transmitter until the CTCSS tone at the output of the transmitter has reached 90% of maximum voltage.

According to TIA-603-C an analog system could have a maximum Receiver Attack Time of 150 ms (250 ms if CTCSS is used) and a maximum Transmitter Attack Time of 100 ms (150 ms if CTCSS is used). In most analog systems the attack times are significantly lower than these values (especially if the system does not have CTCSS).

The following definitions for a P25 system are as follows (from TIA-102.CAAA-A):

### Receiver Late Entry Unsilence Delay

The late entry unsilence delay is the time it takes for a receiver to detect the frame synchronization and network ID on a digital message and generate an audio output. The test is performed for late entry, which means that the synchronizing preamble (Header Data Unit) is absent from the message, and the receiver must detect frame synchronization during the middle of the message. This test applies to a transceiver in the conventional mode of operation.

### Transmitter Power and Encoder Attack Time

Transmitter power and encoder attack time is the time required for a transmitter to prepare and transmit information on the radio channel after changing state from standby to transmit. This test applies to a transceiver in the conventional mode of operation.

According to TIA-102.CAAB-A, a P25 system could have a maximum Receiver Unsilence Delay of up to 460 ms (if both talk groups and encryption is used) and a maximum Transmitter Power and Encoder Attack Time of 100 ms (50 ms Power Attack Time; 100 ms Encoder Attack Time). Receiver Unsilence Delay can be reduced to a maximum of 370 ms if only the talk group OR encryption is used (not both). If neither talk groups nor encryption is used the maximum Receiver Unsilence Delay is 125 ms. In most P25 systems the attack times are relatively close to these maximum values.

P25 Radio Systems also specify a Throughput Delay as follows (from TIA-102.CAAA-A):

### Receiver Throughput Delay

Receiver throughput delay is the time it takes for a receiver to produce an audio output following the introduction of a tone test pattern.

### Transmitter Throughput Delay

The transmitter throughput delay is the time it takes for audio changes in the microphone to be encoded and transmitted over the air.

Throughput delays are separate from attack times. Throughput delays assume that the equipment is already powered and operational. TIA-603-C does not specify an audio throughput delay for analog systems, as the throughput delay is typically negligible. P25 radio systems require much more processing time (Digital Signal Processing, Vocoding, etc.) and typically have much greater throughput delays than conventional analog.

An example of P25 throughput delays is shown below:

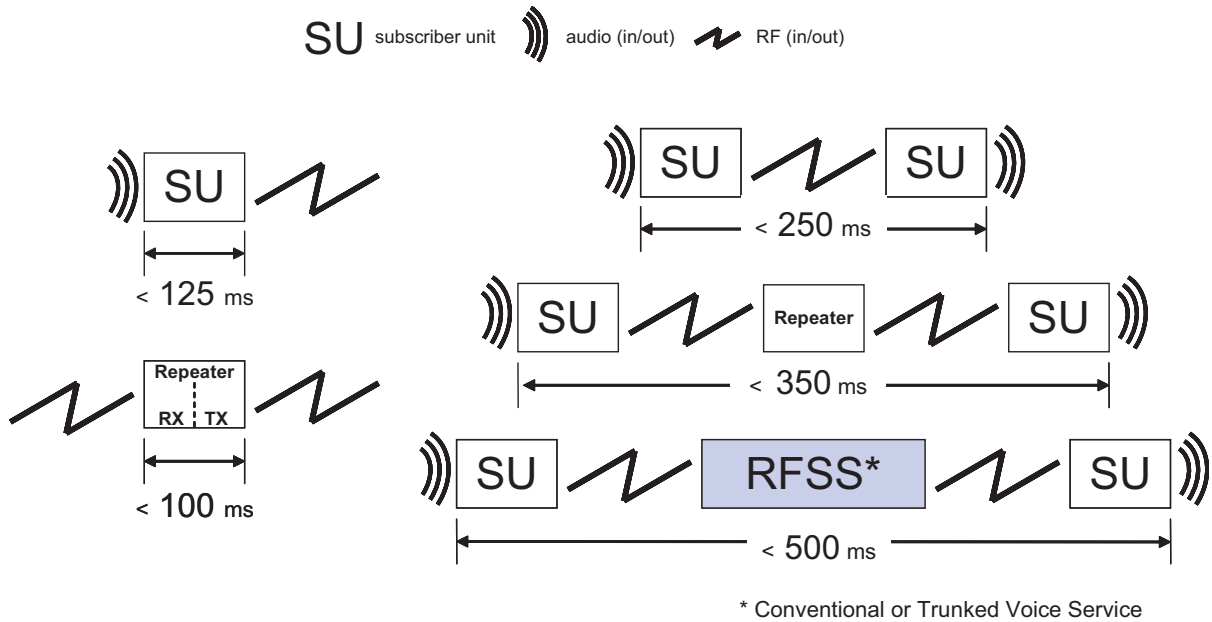

Figure 3-3: Conventional Voice Service Throughput Delays

P25 Radio Systems will have either a slight or great increase in the delays experienced by the user over legacy analog systems, depending on the system infrastructure (more infrastructure to pass the signal through equals more delay). System users may require re-training to accommodate for the greater delays.





## CHAPTER 4: ANATOMY OF THE COMMON AIR INTERFACE

### VOICE

The P25 standard requires the use of the IMBE™ Vocoder to encode speech (tone and audio level) into a digital bit stream. The IMBE™ digital bit stream is broken into voice frames where each voice frame is 88 bits in length (representing 20 ms of speech). The voice frames are protected with error correction codes which add 56 parity check bits resulting in an overall voice frame size of 144 bits. The voice frames are grouped into Logical Link Data Units (LDU1 and LDU2) that contain 9 voice frames each. Each Logical Link Data Unit is 180 ms in length and can be consecutively grouped into Superframes of 360 ms. The superframes are repeated continuously throughout the voice message after a Header Data Unit has been sent. Additional information (encryption, Link Control information and Low Speed Data) is interleaved throughout the voice message.

The voice message structure for a P25 CAI voice transmission is shown in Figure 4-1. The voice message begins with a Header Data Unit (to properly initialize any encryption and link control functions for the message), and then continues with Logical Link Data Units or LDUs. The LDUs alternate until the end of the voice message. The end of the message is marked with a Terminator Data Unit. The Terminator Data Unit can follow any of the other voice data units.

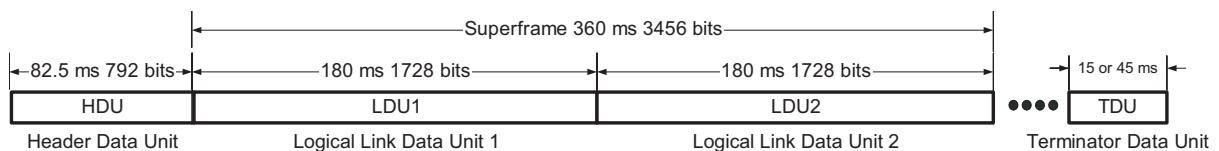

Figure 4-1: P25 Voice Message Structure

# DATA

Data messages are transmitted over the P25 CAI using a packet technique. The data information is broken into fragments, packets and blocks are then error coded and sent as a single packet called a Packet Data Unit. The Packet Data Unit can be of varying lengths and includes a header block that contains the length of the data message.

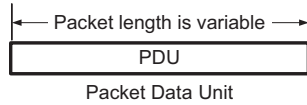
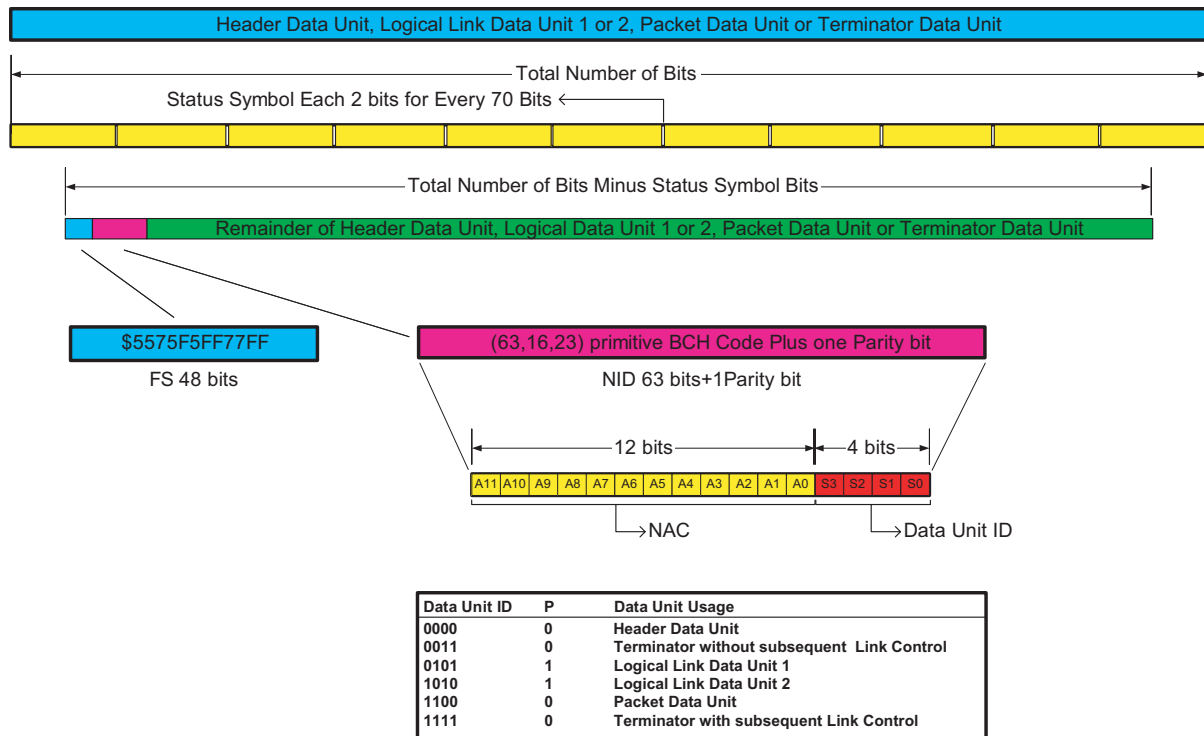

Figure 4-2: P25 Data Message Structure

## FRAME SYNCHRONIZATION AND NETWORK IDENTIFIER

Each data unit (Header Data Unit, Logical Link Data Unit 1, Logical Link Data Unit 2, Packet Data Unit and Terminator Data Unit) begins with a Frame Synchronization (FS) and Network Identifier (NID).



The codes for the 6 different data units are shown. The other 10 data units not shown are reserved for use in trunking or other systems. The P bit is the last (64-th) parity bit in the code word.

Figure 4-3: Frame Synchronization and Network Identifier



## STATUS SYMBOLS

Throughout all of the data units (Header Data Unit, Logical Link Data Unit 1, Logical Link Data Unit 2, Packet Data Unit and Terminator Data Unit) the 2 bit status symbols are interleaved so that there is one status symbol for every 70 bits of information.

| Status Symbol | Meaning                              | Usage                  |
|---------------|--------------------------------------|------------------------|
| 01            | Inbound Channel is Busy              | Repeater               |
| 00            | Unknown, use for talk-around         | Subscriber             |
| 10            | Unknown, use for inbound or outbound | Repeater or Subscriber |
| 11            | Inbound Channel is Idle              | Repeater               |

## HEADER DATA UNIT

A diagram of the header data unit is given in Figure 4-4. The Header Data Unit is composed of the FS (48 bits), NID (64 bits), and the header code word (648 bits). Ten null bits are added to the end of the header code word resulting in 770 bits. Eleven status symbols are also interleaved throughout the Header Data Unit yielding 792 bits total. The Header Data Unit takes 82.5 ms to transmit at 9.6 kbps (the standard bit rate of the P25 CAI).

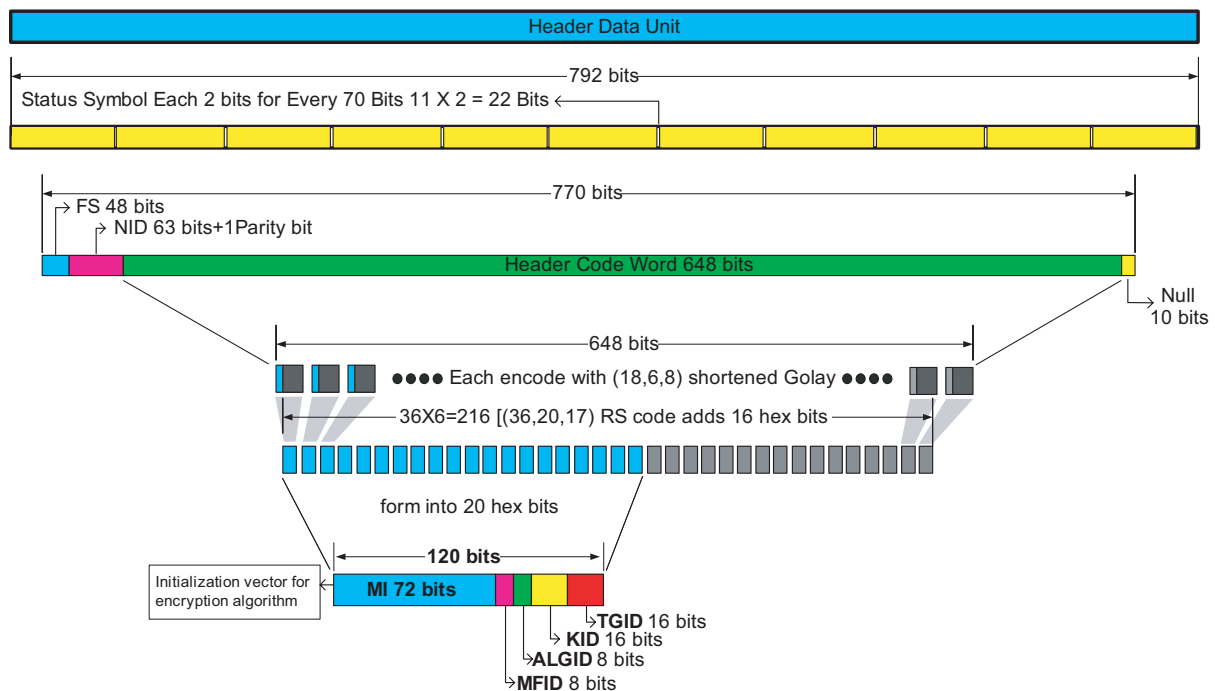

Figure 4-4: Header Data Unit

The Header Code Word field includes a **Message Indicator** (MI), and **Algorithm ID** (ALGID) for the encryption algorithm, and the **Key ID** (KID) for the encryption key as well as the **Manufacturer's ID** (MFID) and **Talk-group ID** (TGID). These information fields total 120 bits.

The information fields are separated into 20 symbols of 6 bits each (these are called hex bits). The symbols or hex bits are encoded with a (36,20,17) Reed-Solomon code to yield 36 hex bits. The 36 hex bits are then encoded with a (18,6,8) shortened Golay code to yield 648 bits total.

## VOICE CODE WORDS

The IMBE™ vocoder converts speech into a digital bit stream where the bit stream is broken into voice frames of 88 bits in length for every 20 ms of speech. This corresponds to a continuous average vocoder bit rate of 4.4 kbps. Voice frames consist of 8 information vectors, labelled  $u_0$ ,  $u_1$ , ...  $u_7$ .

Voice frames are encoded into a 144 bit voice code word as follows:

The voice frame bits are rated according to their effect on audio quality and are then protected using Golay and Hamming codes. The 48 most important bits ( $u_0$  through  $u_3$ ) are error protected with four (23,12,7) Golay code words. The next 33 most significant bits ( $u_4$  through  $u_6$ ) are error protected with three (15,11,3) Hamming code words. The last 7 least significant bits ( $u_7$ ) are not error protected. Construction of the IMBE™ digital bit stream into voice code words is given in Figure 4-5.

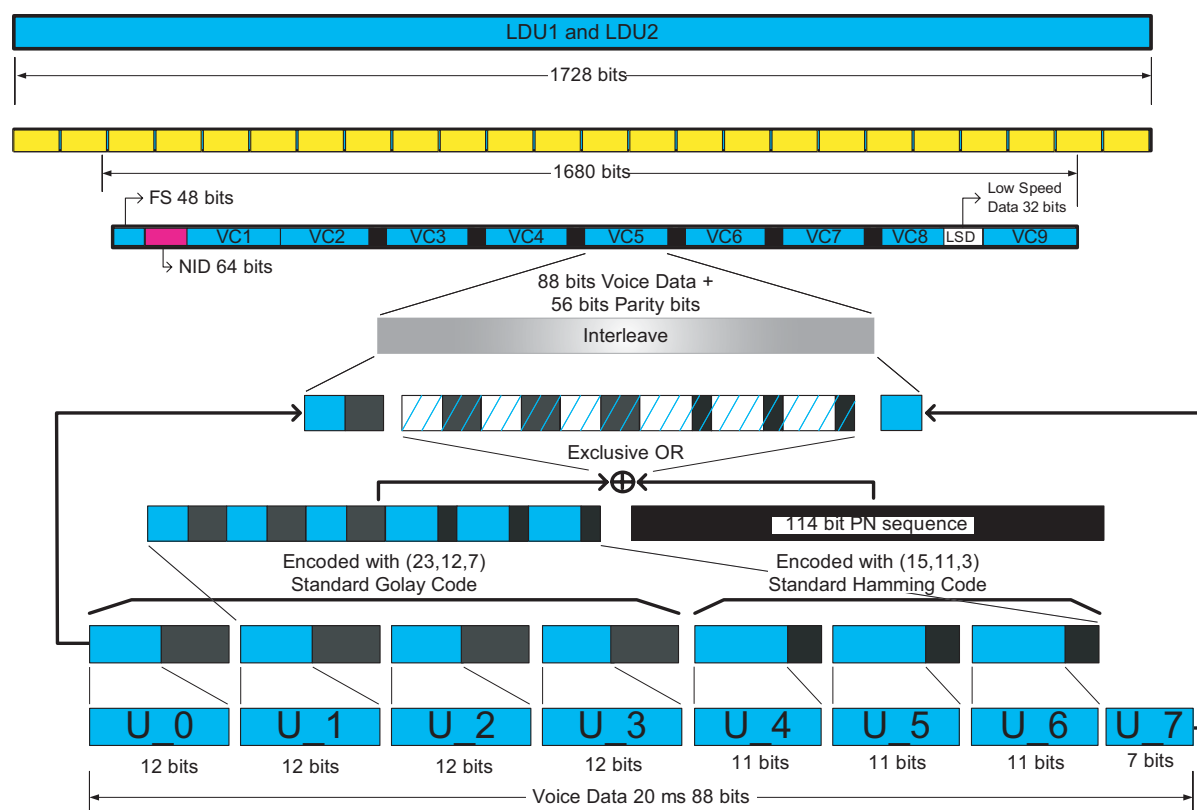

Figure 4-5: Voice Code Word

After the voice data has been error protected using the Golay and Hamming codes, a 114 bit pseudo random sequence (PN sequence) is generated from the 12 bits of  $u_0$ . The error protected voice data in  $u_1$  through  $u_6$  is then bit-wise exclusive-ored with the PN sequence. This information is then interleaved throughout the voice frame to resist fades.

## LOGICAL LINK DATA UNIT 1

A diagram of Logical Link Data Unit 1 (LDU1) is given in Figure 4-6. LDU1 is the first half of a superframe. LDU1 is composed of the FS (48 bits), NID (64 bits), nine voice code words, numbered VC1 through VC9 (1296 bits), Link Control Word (240 bits) and Low Speed Data (32 bits). Twenty-Four Status Symbols are also interleaved throughout LDU1 yielding 1728 bits total. LDU1 takes 180 ms to transmit at 9.6 kbps (the standard bit rate of the P25 CAI).

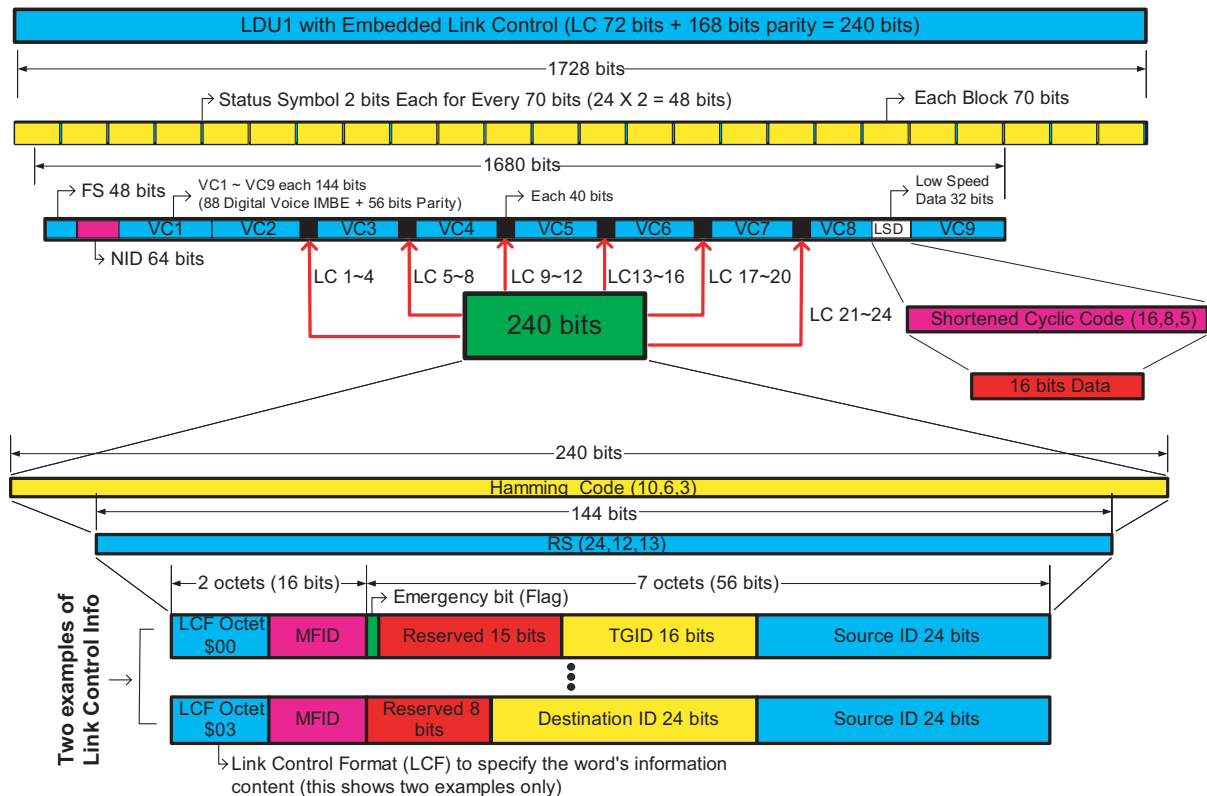

Figure 4-6: Logical Link Data Unit 1

The Link Control Word field may include a **Talk-group ID (TGID)**, a **Source ID**, a **Destination ID**, an **Emergency** indicator, a **Manufacturer's ID (MFID)** and any other necessary call ID information. The Link Control Word uses a variable format since there is too much information for a fixed field format. The type of format is identified by the **Link Control Format (LCF)**. The LCF specifies the the content of the Link Control Word's information. Two format examples are diagrammed in Figure 4-6. All of the information fields (including the LCF) total 72 bits.

The Link Control Word is constructed by serializing the information into 12 hex bits and then encoding them with a (24,12,13) RS code to yield 24 hex bits. The 24 hex bits are then encoded with a (10,6,3) shortened Hamming code to yield 240 bits total. The 240 bits of Link Control (LC) information is then inserted in between the voice code words (VC2 to VC8) in blocks of 40 bits (LC 1-4 is a block of 40 bits, etc.).

## LOGICAL LINK DATA UNIT 2

A diagram of Logical Link Data Unit 2 (LDU2) is given in Figure 4-7. LDU2 is the second half of a superframe. LDU2 is composed of the FS (48 bits), NID (64 bits), nine voice code words, numbered VC10 through VC18 (1296 bits), Encryption Sync Word (240 bits) and Low Speed Data (32 bits). Twenty-Four Status Symbols are also interleaved throughout LDU1 yielding 1728 bits total. LDU2 takes 180 ms to transmit at 9.6 kbps (the standard bit rate of the P25 CAI).

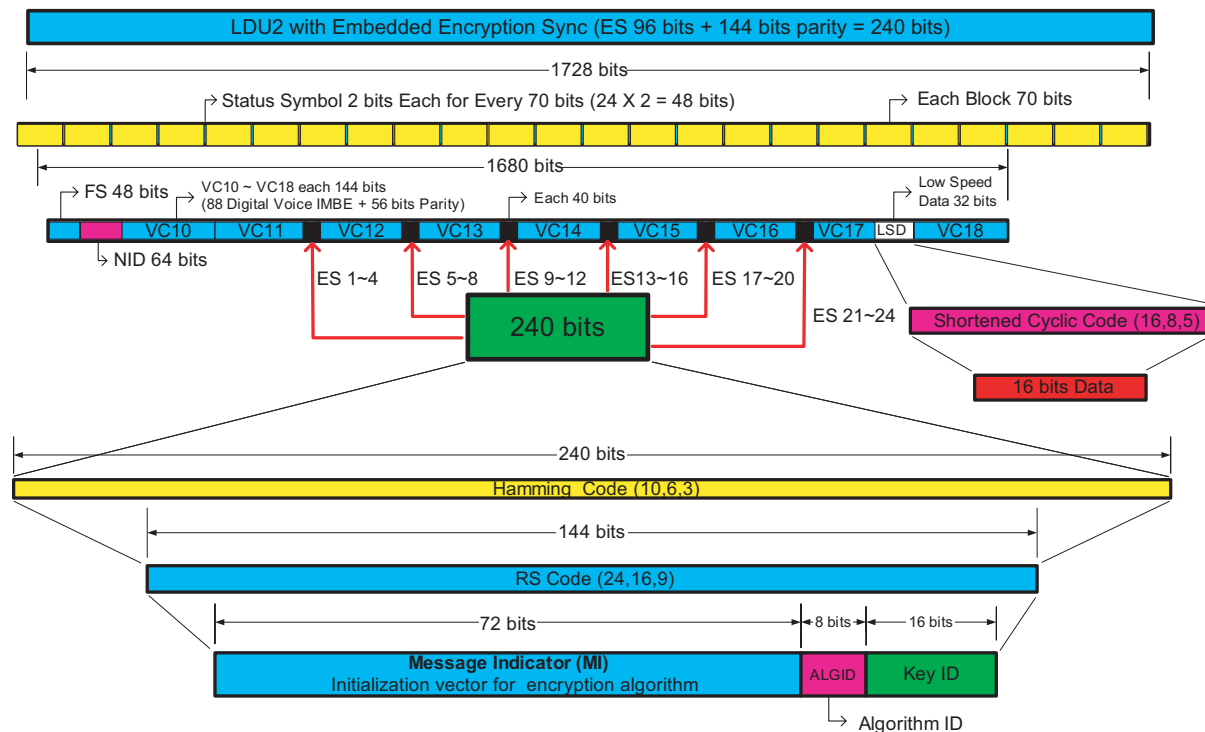

Figure 4-7: Logical Link Data Unit 2

The Encryption Sync Word field includes the **Message Indicator (MI)**, **Algorithm ID (ALGID)** for the encryption algorithm, and the **Key ID (KID)** for the encryption key. This information may be used to support a multi-key encryption system, but is also used for single key and clear messages.

The Encryption Sync Word is constructed by serializing the information into 16 hex bits and then encoding them with a (24,16,9) RS code to yield 24 hex bits. The 24 hex bits are then encoded with a (10,6,3) shortened Hamming code to yield 240 bits total. The 240 bits of Encryption Sync (ES) information is then inserted between the voice code words (VC11 to VC17) in blocks of 40 bits (ES 1-4 is a block of 40 bits, etc.).

## LOW SPEED DATA

Low Speed Data is a serial stream of information. This information is provided for custom applications that are not defined in the CAI. Low Speed Data is comprised of 32 bits of data, 16 bits of which are inserted between VC8 and VC9 in LDU1 and 16 bits are inserted between VC17 and VC18 in LDU2. Each group of 16 bits is encoded with a (16,8,5) shortened cyclic code, creating 32 bits total in each LDU. Low Speed Data has a total capacity of 88.89 bps.

## TERMINATOR DATA UNIT

Voice messages may use one of two different Terminator Data Units.. The simple Terminator Data Unit is composed of the FS (48 bits), NID (64 bits), and Null bits (28 bits). A diagram of the simple Terminator Data Unit is given in Figure 4-8.

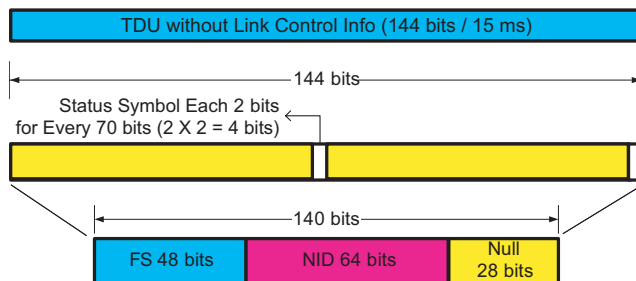

Figure 4-8: Terminator Data Unit without Link Control Info

The Terminator Data Unit can also be sent with the Link Control Word embedded in it. A diagram of the expanded Terminator Data Unit is given in Figure 4-9. The Link Control Word is the same as the Link Control Word used in LDU1, except that it is error protected with a Golay code instead of the Hamming code.

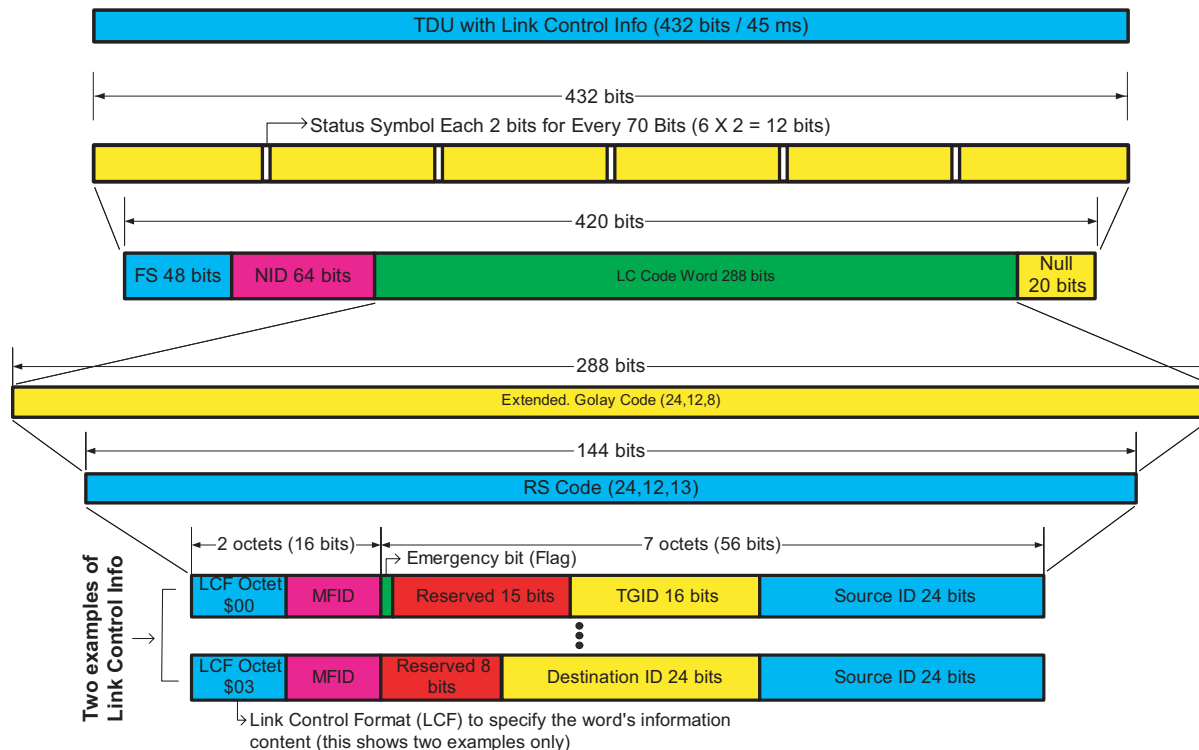

Figure 4-9: Terminator Data Unit with Link Control Info

When the voice message is finished, the transmitter continues the transmission, by encoding silence for the voice, until the Logical Link Data Unit is completed. Once the Logical Link Data Unit is completed, the transmitter then sends the Terminator Data Unit to signify the end of the message. The terminating data unit may follow either LDU1 or LDU2.

## PACKET DATA UNIT

A diagram of the Packet Data Unit is given in Figure 4-10. Data Packets use two different types of data with two different structures. Confirmed or unconfirmed delivery may be used to send data. Confirmed delivery is used when the recipient of the packet is required to send an acknowledgment of receipt. Unconfirmed delivery does not require an acknowledgment of receipt. Confirmed or unconfirmed delivery is defined in the header block.

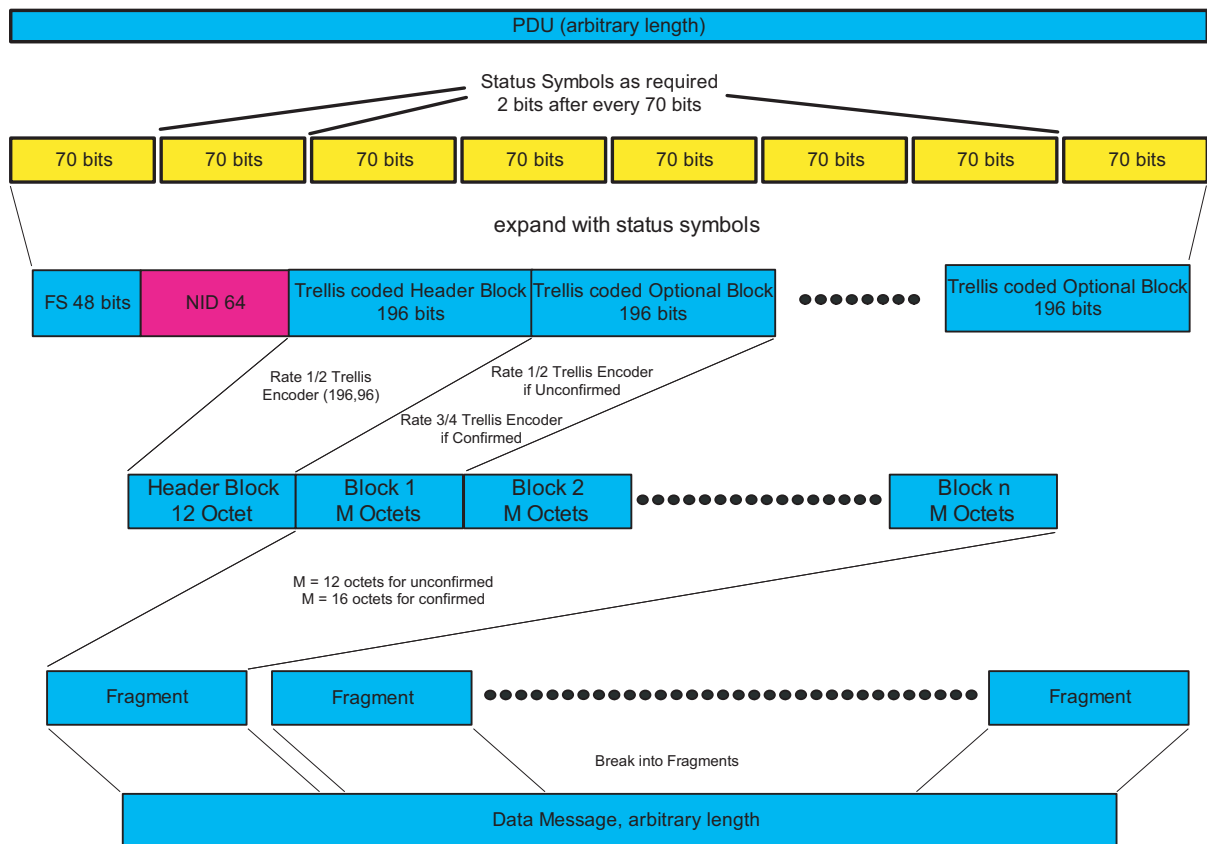

Figure 4-10: Data Packet Unit

Data is sent in variable length packets and the length of the data packet is defined in the header block. When a data packet ends, nulls are added until the next status symbol.

The data message is split into fragments, then formed into packets, and the packets are then split into a sequence of information blocks that are error protected by a Trellis code. These blocks are then transmitted as a single data packet.







## CHAPTER 5: IMBE™ AND AMBE+2™ VOCODERS

P25 radios use the Improved Multi-Band Excitation (IMBE™) vocoder, developed by Digital Voice Systems, Inc. (DVSI), to convert analog speech into a digital bit stream suitable for transmission over the P25 Common Air Interface (CAI). At the transmitter, the vocoder consists of an encoder that converts the analog voice signal from a microphone into a digital bit stream, while at the receiver, the vocoder consists of the decoder that converts the digital bit stream back into analog voice suitable for playback through a speaker.

In P25, analog voice is converted into a digital bit stream with a net bit rate of 4.4 kbps for voice information and a gross bit rate of 7.2 kbps after error control coding (note: after vocoding, 2.4 kbps of signaling information is added to make 9.6 kbps total). The vocoder uses a frame size of 20 ms.

P25 selected the IMBE™ vocoder in 1992 after a competition with several other proposed vocoders. All the vocoders were evaluated through an extensive set of Mean Opinion Score (MOS) tests that compared voice quality for different male and female voices in a range of conditions. These conditions included simulations of vehicles traveling at various rates of speed. In addition speech was tested with various background noises, such as sirens, gunshots, and traffic, that are likely to be encountered by a public safety radio system. The result of this evaluation was that the IMBE™ vocoder was judged best by a panel of listeners under almost every test condition. As a result the IMBE™ vocoder was selected as the standard vocoder for the P25 system.

The IMBE™ vocoder is a model-based speech coder, or vocoder, that does not try to reproduce the input speech signal on a sample-by-sample basis. Instead, the IMBE™ vocoder constructs a synthetic speech signal that contains the same perceptual information as the original speech signal. The IMBE™ vocoder is based on the Multi-Band Excitation (MBE) speech model that was developed at the Massachusetts Institute of Technology (MIT) from research on high quality, robust speech modeling.

The IMBE™ vocoder models each segment of speech as a frequency dependent combination of voiced (more periodic) and unvoiced (more noise-like) speech. This ability to mix voiced and unvoiced energy is a major advantage over traditional speech models that require each segment of speech to be entirely voiced or unvoiced. This flexibility gives the IMBE™ vocoder higher voice quality and more robustness to background noise.

The IMBE™ encoder uses sophisticated algorithms to estimate a set of model parameters for each segment of the incoming speech signal. These parameters consist of: (1) a fundamental frequency, to represent the pitch of the speaker; (2) a set of Voiced/Unvoiced (V/UV) decisions, to represent the mixture of voiced and unvoiced energy; and (3) a set of spectral magnitudes, to represent the frequency response of the vocal tract. The encoder computes a Discrete Fourier Transform (DFT) for each segment of speech and then analyzes the frequency content to extract the model parameters for that segment. These model parameters are then quantized into 88 bits, and the resulting voice bits are then output as part of the 4.4 kbps of voice information produced by the IMBE™ encoder. An additional 2.8 kbps of error correction information is then added to the voice information to produce the 7.2 kbps bit stream that is transmitted over the CAI.

The IMBE™ decoder reproduces analog speech from the 7.2 kbps digital bit stream that is received over the CAI. The decoder first uses the error correction information included in the received bit stream to attempt to correct any bit errors that may have been introduced by the radio channel. The decoder then reconstructs the model parameters for each segment and uses these parameters to synthesize both a voiced signal and an unvoiced signal. The voiced signal represents the period portions of the speech and is synthesized using a bank of harmonic oscillators. The unvoiced signal represents the noise-like portions of the speech and is produced by filtering white noise. The decoder then combines these two signals and passes the result through a digital-to-analog converter to produce the analog speech output.

Recently DVSI has developed a Half-Rate (3.6 kbps) vocoder that has been proposed for use in P25 Phase 2. Designed as an extension of the current 7.2 kbps IMBE™ vocoder used in P25, DVSI's new Half-Rate vocoder operates at a net bit rate of 2.45 kbps for voice information and a gross bit rate of 3.6 kbps after error control coding. This represents a 50% reduction in bit rate as compared to the current 7.2 kbps IMBE™ vocoder used in P25 Phase 1.

DVSI has also introduced new Enhanced Vocoders for P25 based on DVSI's latest AMBE+2™ Vocoder technology. These Enhanced Vocoders are backward compatible with both the standard P25 Full-Rate and proposed Half-Rate vocoders, while providing improved voice quality, better noise immunity, tone capability, and other new features. The Enhanced Vocoders significantly improve the voice performance of the P25 system, while facilitating the migration and interoperability between new and existing P25 equipment. DVSI's vocoder technology is used extensively in digital radio systems and in mobile satellite telephony worldwide.



## CHAPTER 6: P25 GLOSSARY OF TERMS

---

### Access Method

The ability and means necessary to store data, retrieve data, or communicate with a system. FDMA, TDMA and CDMA are examples.

---

### ALGID

Abbreviation for the eight BITs which identify the encryption algorithm in systems with multiple encryption algorithms.

---

### Algorithm

A finite set of well defined rules for the solution of a problem, in a finite number of steps.

---

### APCO

Abbreviation for "Association of Public-Safety Communication Officials"

---

### APCO Project 16A

A suite of operational requirements developed by APCO for Public Safety trunked radio systems. It is titled "900 MHz Trunked Communications System Functional Requirements Development, Dated March 1979."

---

### ARQ

Automatic Retry Request to retry corrupted data packets

---



---

### ASCII

Abbreviation for "American Standard Code for Information Interchange"  
- A seven-BIT code that defines 128 characters, including control characters, letters, numbers, and symbols.

---

### Audio throughput delay

Waiting time delay from audio input at sending unit until audio output at receiving unit.

---

### Backward Compatibility

Ability of new units to operate within an "old" system infrastructure or to directly intercommunicate with an "old" unit.

---

### Bandwidth

The difference between the limiting frequencies of a continuous frequency band. Typically measured in Kilohertz. May be considered the amount in kilohertz required for a single communications channel.

---

### BCH

Abbreviation for "Bose-Chaudhuri-Hocquenghem," a binary coding scheme.

---

### BER

Abbreviation for "BIT Error Rate"

---

---

**BER Threshold**

The level at which the BIT error rate exceeds the error correction capability and communication fails in a digital system.

---

**BIT**

Acronym for binary digit.

---

**BIT Rate**

In a BIT stream, the number of BIT occurring per unit time, usually expressed as BITS per second or BPS.

---

**BIT Stuffing**

A method used for synchronizing BIT streams that do not necessarily have the same or rationally related BIT rates, by adding non-information (“stuffing”) BITS.

---

**BPS**

Abbreviation for BITS Per Second, a data rate measure.

---

**BR**

Base Radio, a reference designating a base station radio.

---

**C4FM**

The acronym for a 4-ary FM transmitter which uses QPSK modulation to work with a CFDD compatible receiver.

---

**CAI**

Abbreviation for Common Air Interface.

---

**Call Congestion**

The ratio of calls lost due to a lack of system resources to the total number of calls over a long interval of time.

---

**Call Delay**

The delay experienced when a call arriving at an automatic switching device finds no idle channel of facility available to process the call immediately.

---

**Call Set-up Time**

The overall length of time required to establish a circuit switched call between users or terminals.

---



---

**Capture Effect**

An effect associated with the reception of frequency modulated signals in which if two signals are received on or near the same frequency, only the stronger of the two will appear in the output.

---

**Carrier Noise Level**

The noise level resulting from undesired variations of a carrier in the absence of any intended modulation.

---

**Carrier Squelch**

A radio receive mode of operation that causes the receiver to unmute in the presence of a received signal.

---

**CDMA**

Abbreviation for Code Division Multiple Access. A coding scheme in which digital information is encoded in an expanded bandwidth format. An access method that allocates each user a coded set of channels on which to send outgoing information frames.

---

**CELP**

Abbreviation for a “Code Excited Linear Predictive” voice coding technique (analog to digital voice conversion).

---

**CFB**

Abbreviation for a “Cipher Feedback” an encryption synchronization method

---

**CFDD**

The acronym for a receiver which detects QPSK-C compatible modulation. CFDD stands for Compatible Frequency Discriminator Detection.

---

**Channel**

A single unidirectional or bidirectional path for transmitting or receiving, or both, of electrical or electromagnetic signals.

---

**Channel Rate**

The data rate at which information is transmitted through the channel, typically stated in BITS per second (BPS).

---

|                                       |   |                 |  |
|---------------------------------------|---|-----------------|--|
| <b>Channel Spacing</b>                | Typically measured in kilohertz from the center of one channel to the center of the next-adjacent-channel. May, or may not, be identical to bandwidth.  | <b>CSMA/CD</b>  | Abbreviation for “Carrier Sense, Multiple Access” with “Collision Detection.” It is a multi-access technique in which stations listen before transmitting. A transmitting station detecting a collision aborts its transmission.   |
| <b>C/I</b>                            | Abbreviation for “Carrier to Interference” signal ratio.  | <b>CTCSS</b>    | Abbreviation for “Continuous Tone-Controlled Squelch System.”  |
| <b>CM</b>                             | Abbreviation for a “Circuit Merit” A delivered voice quality test and rating strategy   | <b>CVSD</b>     | Abbreviation for “Continuously Variable Slope Delta” modulation technique. A type of delta modulation in which the size of the steps of the approximated signal is progressively increased or decreased as required to make the approximated signal closely match the input analog signal. |
| <b>CODEC</b>                          | A COder-DECoder device (analog to digital voice conversion).  | <b>DAM</b>      | Abbreviation for a “Diagnostic Acceptance Measure.” An audio acceptability test.   |
| <b>Common Air Interface (CAI)</b>     | A radio to radio signal path defined in terms of Access Method, Modulation Scheme, Vocoding Method, Channel Data Rate and Channel Data Format.  | <b>DCE</b>      | Abbreviation for “Data Circuit terminating Equipment” through which the DTE is connected to a network.   |
| <b>Common channel signaling (CCS)</b> | A signaling method using one of the channels on a multichannel network for the control, accounting and management of traffic on all of the channels of the network.   | <b>DCPSK</b>    | Abbreviation for the “Differential Coherent Phase Shift Keying” modulation technique. A method of encoding information in terms of phase changes, rather than absolute phases, and detected by comparing phases of adjacent BITS.  |
| <b>Console</b>                        | A subsystem comprised of one or more elements from a single manufacturer that is the device(s) which allows a person(s) to effectively and efficiently use and control the capabilities and the functions of the radio system(s) to which it is attached. | <b>DCT</b>      | Abbreviation for “Discrete Cosine Transform” a technique used in vocoding.   |
| <b>Covert</b>                         | Adjective used to describe undercover operations by government agents. “Covert” communications are generally encrypted.   | <b>Deadlock</b> | A situation in which traffic ceases to flow and throughput drops to Zero.  |
| <b>CQPSK</b>                          | The acronym for a QPSK IQ transmitter which uses QPSK-C modulation to work with a CFDD compatible receiver.   | <b>De-Key</b>   | Turn the transmitter off (release the Push-to-Talk switch).  |
| <b>CRC</b>                            | Cyclic Redundancy Checksum for data error detection.  |                 |  |

---

**Delay Time**

The sum of waiting time and service time in a queue.

---

**DES**

Abbreviation for “Digital Encryption Standard”

---

**Differential Modulation**

A type of modulation in which the choice of the significant condition for any signal element is dependent on the choice for the previous signal element.

---

**DNA**

Abbreviation for DEC’s “Digital Network Architecture”.

---

**DPA**

Abbreviation for “Demand Protocol Architecture”

---

**DPSK**

Abbreviation for “Differential Phase Shift Keying” modulation technique. A method of encoding information for digital transmission. In DPSK, each signal element is encoded as a change in the phase of the carrier with respect to its previous phase angle.

---

**DQPSK**

Abbreviation for “Differential Quadrature Phase Shift Keying” modulation technique.

---

**DRT**

Abbreviation for a “Diagnostic Rhyme Test” An audio intelligibility test

---

**DS0**

Abbreviation for a 64 kbps telephone service

---

**DS1**

Abbreviation for a 1.544 MBPS telephone service.

---

**DSP**

Abbreviation for “Digital Signal Processor” a specialized microcomputer.

---

---

**DTE**

Abbreviation for “Data Transmission Equipment” (user systems).

---

**DTMF**

Abbreviation for “Dual-Tone Multi-Frequency” - a signaling scheme used by the telephone system in which two voice band tones are generated for each keypad key press.

---

**Dual Mode Equipment**

Equipment which will transmit and receive information using either the APCO Project 25 standard digital signals or current analog standard signals without modification or interfacing devices.

---

**DVP**

Abbreviation for “Digital Voice Protection” - one of several encryption algorithms used to provide secure voice radio transmissions.

---

**ECC**

Abbreviation for “Error Correction Code” See Error Correction.

---

**Ed Interface**

The label given to the Host and Data Interface in the General System Model.

---

**En Interface**

The label given to the Network Management Interface in the General System Model.

---

**Encryption**

A coding of plain text (or clear voice) into unintelligible forms for secure transmission.

---

**Error Correction**

Digital coding technique for detecting and correcting information transmission errors.

---

**ES**

Encryption Synchronization information embedded in a voice data frame

---

---

**Et Interface**

The label given to the Telephone Interconnect Interface in the General System Model.

---

**EVM**

Error Vector Magnitude

---

**ETSI**

Abbreviation for “European Telecommunications Standards Institute.”

---

**FCC**

Abbreviation for “Federal Communications Commission”

---

**FDMA (Frequency Division Multiple Access)**

Access method that divides a communication channel into two or more individual channels.

---

**FEC**

Abbreviation for “Forward Error Correction”

---

**FIFO(FCFS)**

A service discipline of queuing systems, based on the First In, First Out rule.

---

**FIPS**

Abbreviation for “Federal Information Processing Standard.”

---

**Firmware**

Software that is permanently stored in a hardware device which allows reading and executing the software, but not writing or modifying the software.

---

**Flow Control**

In data communications systems, a device function that controls the rate at which data may be transmitted from one terminal so that it is equal to the rate at which it can be received by another terminal.

---

**FNE**

Abbreviation for “Fixed Network Equipment.”

---

---

**Format**

In data transmission, the arrangement of contiguous BITS or Frame sequences which make a group, word, message or language.

---

**Frame**

In data transmission, the sequence of contiguous BITS bracketed by and including beginning and ending flag sequences. Unit of data of the data link layer.

---

**FS**

Frame Synchronization to mark the first information BIT

---

**FSK**

Frequency Shift Keying A form of frequency modulation in which the modulating signal shifts the output frequency between predetermined values.

---

**FSNF**

Abbreviation for “Fragment Sequence Number Field” in the Common Air Interface.

---

**FTP**

Abbreviation for “File Transfer Protocol.”

---

**Full-Duplex**

An operating method in which transmission is permitted, simultaneously, in both directions of a telecommunications channel.

---

**G Interface**

The label given to the Inter-RF-Subsystem Interface in the General System Model.

---

**Galois Field (GF)**

A data field used to calculate parity checks for a Reed-Solomon code.

---

**Gateway**

An interface that provides the necessary protocol translation between disparate networks.

---



---

**GMSK**

Abbreviation for “Gaussian Minimum Shift Keying” A form of frequency modulation in which the modulating signal shifts the output frequency between predetermined values. A form of MSK which uses Gaussian low pass filtering of the binary data to reduce sideband energy.

---

**Golay**

Name of a standard error correction code

---

**GPS**

Abbreviation for “Global Positioning System”

---

**Graceful Close**

Method used to terminate a connection at the transport layer with no loss of data.

---

**GSM™**

Abbreviation for “Group Specialized Mobile” radio service

---

**Half-Duplex**

That mode of operation in which communications occurs between two terminals in either direction, but only one direction at a time. May occur on a half-duplex or duplex circuit but not on a simplex circuit.

---

**HDLC**

Abbreviation for “Highlevel Data Link Control.” The international standard for data link control developed by ISO.

---

**Hex BIT**

6 BITs grouped together to represent a Reed-Solomon code symbol

---

**Hierarchical Numbering**

Multiple level numbering. An example is the telephone number made up of levels such as “Country Code,” “Area Code,” “Exchange Number” and “Line Number.”

---

**Hierarchical Routing**

Multiple level routing. Used both in packet switching and circuit switching.

---



---

**Hub Polling**

One of the polling techniques. Permission to transmit is passed sequentially from one designated user to another.

---

**I/O**

Abbreviation for “Input and/or Output.”

---

**IEEE**

Abbreviation for “Institute of Electrical and Electronics Engineers, Inc.”

---

**ILS**

Abbreviation for an “Input buffer Limiting Scheme.” A flow control scheme that blocks overload locally generated arrivals by limiting their number at a buffer.

---

**IMBE™**

Abbreviation for “Improved Multi Band Excitation”.

---

**Inband Signaling**

Signaling that uses frequencies or time slots within the bandwidth of the information channel.

---

**Incarnation Number**

A unique name or number sent within a data unit to avoid duplicate data unit acceptance.

---

**IP**

Abbreviation for “Internetwork Protocol” in the ISO activities, as well as Internet Protocol in ARPA protocol activities.

---

**IPR**

Abbreviation for “Intellectual Property Rights”. Patents, Copyrights or similar rights which are proprietary to an individual, group or company.

---

**IQ Origin Offset**

Is a measurement that shows how well balanced the IQ modulators in the transmitter are and if there is excessive leakage around them.

---



|                      |  |                          |   |
|----------------------|--|--------------------------|---|
| IRAC                 | Abbreviation for the Federal Government "Interdepartmental Radio Advisory Committee."  | Local Area Network (LAN) | A network covering small geographic areas.  |
| ISDN                 | Abbreviation for "Integrated Services Digital Network" All-digital network handling a multiplicity of services with standard interfaces for user access. An integrated digital network in which the same time-division switches and digital transmission paths are used to establish connections for different services. | LSB                      | Abbreviation for "Least Significant BIT."   |
| ISO                  | Abbreviation for "International Standards Organization"  | LSD                      | Low Speed Data embedded in digital voice  |
| Key                  | The parameter defining an encryption code or method.   | LU                       | Abbreviation for "Logical Unit."  |
| Key Tag              | The parameter defining one of several encryption codes or methods.   | MDT                      | Abbreviation for "Mobile Data Terminal"   |
| KID                  | Sixteen BITS which identify the encryption key in systems with multiple encryption keys.   | MFID                     | Abbreviation for "Manufacturer's Identity." An eight-BIT field identifying manufacturer of the radio equipment.   |
| LAN                  | Abbreviation for "Local Area Network."   | MI                       | Message Indicator to initialize encryption  |
| LC                   | Link Control information embedded in digital voice   | MIB                      | Abbreviation for "Management Information BITS."   |
| Linear Amplifier     | A radio final amplifier in which the output is linearly proportional to the input. Usually a class A amplifier.  | MIL-STD                  | Abbreviation for "Military Standard".   |
| Linearized Amplifier | A radio final amplifier in which the output is mostly linearly proportional to the input. Usually a class AB amplifier.  | MODEM                    | An acronym for MOdulator/ DEModulator. A device for converting digital signals into quasi-analog signals for transmission over analog communications channels and for reconverting the quasi-analog signals into digital signals. |
| LLC                  | Logical Link Control sublayer of the OSI Data Link Layer   | Modulation               | A controlled variation of any property of a carrier wave for the purpose of transferring information.   |
| LMR                  | Abbreviation for "Land Mobile Radio"   | MOS                      | Abbreviation for "Mean Opinion Score." An audio quality test.   |
|                      |  | MR                       | Mobile Radio, a reference designating a mobile or portable subscriber unit  |
|                      |  | MSB                      | Abbreviation for "Most Significant BIT."  |

---

**MSK**  
 Abbreviation for “Minimum Shift Keying.”  
 A form of frequency modulation in which the modulating signal shifts the output frequency between predetermined values. Sometimes called fast frequency shift keying.

---

**NASTD**  
 Abbreviation for “National Association of State Telecommunications Directors.”

---

**NCS**  
 Abbreviation for “National Communications Systems group” a U.S. Federal agency.

---

**NID**  
 Network Identifier code word following the frame sync

---

**NIST**  
 Abbreviation for “National Institute of Standards and Technology” a U.S. Federal agency.

---

**NPSPAC**  
 Abbreviation for “National Public Safety Planning Advisory Committee” A user/industry advisory committee established by the Federal Communications Commission to develop a plan for the use of the 800 MHz Public Safety spectrum.

---

**NSA**  
 Abbreviation for the U.S. Federal Government “National Security Agency.”

---

**NTIA**  
 Abbreviation for “National Telecommunications and Information Administration”. a U.S. Federal agency.

---

**Octal**  
 Base 8 notation for numbers, also called radix 8

---

**Octet**  
 Eight BITs grouped together, also called a byte

---

**OFB**  
 Abbreviation for a “Output Feedback.”  
 An encryption synchronization method.

---



---

**Open System**  
 A system whose characteristics comply with specified standards and that therefore can be connected to other systems that comply with these same standards. Note: contrast with closed system (FP) (ISO).

---

**Open Systems Interconnection (OSI)**  
 A logical structure for network operations standardized within the ISO; a seven-layer network architecture being used for the definition of network protocol standards to enable any OSI-compliant computer or device to communicate with any other OSI-compliant computer or device for a meaningful exchange of information

---

**Operating System**  
 An integrated collection of routines that service the sequencing and processing of programs by a computer. Includes such functions as memory allocation, file management, input and output operations, communications and interfacing to other application software.

---

**OTAC**  
 Abbreviation for “Over-The-Air-Control.”

---

**OTAP**  
 Abbreviation for “Over-The-Air-Programming.”

---

**OTAR**  
 Abbreviation for “Over-The-Air-Rekeying.”

---

**Packet**  
 A sequence of binary digits, including data and control signals, that is transmitted and switched as a composite whole. The data, control signals and possibly error control information, are arranged in a specific format.

---

**Packet Switching**  
 The process of routing and transferring data by means of addressed packets so that a channel is occupied during the transmission of the packet only, and upon completion of the transmission the channel is made available for the transfer of other traffic.

---

---

**PBX**

Abbreviation for “Private Branch Exchange.” A privately owned switch, generally of relatively small size, connected via output trunks to the public switched telephone network.

---

**PCM**

Abbreviation for “Pulse Coded Modulation.” That form of modulation in which the modulating signal is sequentially sampled, quantized, and coded into a binary form for transmission over a digital link.

---

**PDT**

Abbreviation for “Portable Data Terminal”

---

 **$\pi/4$  DQPSK**

Abbreviation for “Differential Quadrature Phase Shift Keying” modulation technique.  $\pi/4$  indicates 90° phase angles.

---

 **$\pi/4$  QPSK**

Abbreviation for “Quadrature Phase Shift Keying” modulation technique. PSK using four phase states.  $\pi/4$  indicates 90° phase angles.

---

**PN Sequence**

A pseudo random BIT sequence used in vocoding.

---

**Polling**

A network control system in which a designated control station invites its tributary stations to transmit in any sequence specified by the control station.

---

**POTS**

Abbreviation for “Plain Old Telephone Service.”

---

**PPP**

Abbreviation for “Point-to-Point Protocol.”

---

**Processing Delay**

The time in ms required for the coding and decoding of voice or data information.

---



---

**Protocol**

A set of unique rules specifying a sequence of actions necessary to perform a communications function.

---

**PSDN**

Abbreviation for “Public Switched Data Network.”

---

**PSK**

Abbreviation for “Phase Shift Keying.” A method of modulation used for digital transmission wherein the phase of the carrier is discretely varied in relation to a reference phase, or the phase of the previous signal element, in accordance with the data to be transmitted.

---

**PSTN**

Abbreviation for “Public Switched Telephone Network.”

---

**PTT**

Abbreviation for “Push-to-Talk”, the switch on a subscriber unit which, when pressed, causes the subscriber unit to transmit.

---

**Quadrature Modulation**

Modulation of two carrier components 90° apart in phase by separate modulating functions.

---

**QAM**

Abbreviation for “Quadrature Amplitude Modulation.” Quadrature modulation in which some form of amplitude modulation is used for both inputs.

---

**QPSK**

Abbreviation for “Quadrature Phase Shift Keying” modulation technique. PSK using four phase states.

---

**Reed-Solomon (RS)**

An error correction coding scheme for binary data fields.

---

**Reference Vocoder**

The particular implementation of the APCO Project Vocoder available from Digital Voice Systems Incorporated as Model VC-20-PRJ25. This is the agreed upon reference implementation of the APCO Project 25 Vocoder.

---

---

**RF**

Abbreviation for “Radio Frequency.”

---

**RF-Subsystem**

The RF infrastructure which is bounded by the five open APCO Project 25 interfaces and three standard computer network gateway interfaces. It is the RF equipment and related non standard peripheral equipment which provides a standardized RF communication channel. One of the APCO Project 25 interfaces is the Common Air Interface (CAI).

---

**RS-232**

An asynchronous, serial, data transmission standard that defines the required sequence, timing, and hardware interface.

---

**RS**

Reed-Solomon error correction code.

---

**SAP**

Service Access Point, where a network provides a service.

---

**Setup Delay**

The time in ms required to actuate equipment for transmission and reception.

---

**Signal**

The detectable transmitted energy which carries information from a transmitter to a receiver.

---

**SINAD**

Abbreviation for “Signal plus Noise And Distortion” to “noise and distortion” ratio.

---

**SMRS**

Abbreviation for “Specialized Mobile Radio Service.”

---

**Squelch**

A radio circuit that eliminates noise from the speaker when no transmitted signal is present.

---

**STC**

Abbreviation for “Sinusoidal Transform Coding” A voice coding technique (analog to digital voice conversion).

---

---

**Subscriber Unit**

A mobile or portable radio unit used in a radio system.

---

**Subsystem**

A defined portion of any organized assembly of resources and procedures united and regulated by interaction or interdependence to accomplish a set of specific functions.

---

**System**

Any organized assembly of resources and procedures united and regulated by interaction or interdependence to accomplish a set of specific functions.

---

**T1 system**

A digital communication system designed to handle 24 voice channels at 64 kbps each. Digital transmission media to support 1.544 Mbps. transmission speed.

---

**TCP**

Abbreviation for “Transmission Control Protocol.” ARPAnet developed transport layer protocol.

---

**TDMA (Time Division Multiple Access)**

A communications technique that uses a common channel for communication among multiple users by allocating unique time slots to different users.

---

**Telnet**

Terminal-remote host protocol developed for ARPAnet.

---

**TGID**

Abbreviation for “Talk-Group Identifier.” A twelve BIT field identifying talk-group of the radio message.

---

**Throughput Delay**

The total time in ms between the initiation of a voice or data signal, ie. push-to-talk, until the reception and identification of the identical signal at the received output speaker or other device.

---

**TIA**

Abbreviation for “Telecommunications Industry Association”

---

---

**Time-Out-Timer**

A function that limits the transmission period to a pre-defined time. The user will automatically stop transmitting when the timer goes off after the pre-defined time.

---

**TPDU**

Abbreviation for “Transport Protocol Data Unit.”

---

**Transmission Delay**

The time in ms required for transmission of a voice frame or data packet through a communication channel.

---

**Trellis Code**

Type of error correcting code for digital modulation

---

**TriBIT**

3 BITS grouped together into a symbol for a trellis code

---

**TRS**

Technical Requirements Specification

---

**Trunk**

A single transmission channel between two points that are switching centers or nodes, or both.

---

**Trunked (system)**

Systems with full feature sets in which all aspects of radio operation, including RF channel selection and access, are centrally managed.

---

**ULP**

Abbreviation for “Upper Layer Protocol.” Layer above TCP.

---

**Um Interface**

The label given to the Common Air Interface reference point in the General System Model.

---

**VOCODER (Voice-Coder)**

A type of voice coder. Usually consisting of a speech analyzer and a speech synthesizer which convert analog speech into digital signals for transmission and digital signals back into artificial speech sounds for reception.

---



---

**VSELP**

Abbreviation for a “Vector Sum code Excited Linear Predictive” voice coding technique (analog to digital voice conversion).

---

**WAN**

Abbreviation for “Wide-area Network”

---

**X.25**

The CCITT three-layered interface architecture for packet switching connecting a DTE to a DCE.

---





**Daniels Electronics Ltd.**  
43 Erie Street, Victoria, BC  
Canada V8V 1P8  
[www.danelec.com](http://www.danelec.com)  
[sales@danelec.com](mailto:sales@danelec.com)

Toll Free Canada and USA:  
phone: 1-800-664-4066  
fax: 1-877-750-0004

International:  
phone: 250-382-8268  
fax: 250-382-6139

© 2004 Daniels Electronics Ltd.  
All Rights Reserved.

TG-001-1-0-1



[www.danelec.com](http://www.danelec.com)